



WELCOME TO THE ULTIMATE HOT TUB EXPERIENCE!

We sincerely hope your spa life is a pleasant experience. If problems should arise, contact your authorized Marquis® dealer. Or contact Marquis Corp. at any of the following:

Email: service@marquiscorp.com
Web: www.marquisspas.com
Marquis Corp.
596 Hoffman Road
Independence, OR 97351, USA

This manual is provided to enhance your enjoyment of your spa and to prevent non-warranty situations. It is your sole responsibility to read, understand and comply with the instructions in the owner's manual. Please save your original sales receipt for reference in case of a future warranty claim. Failure to use, maintain or install the spa in compliance with this owner's manual could result in loss of warranty coverage.

SERIAL NUMBER LOCATION

You will find the serial number on the tag in the equipment area.

PLEASE FILL OUT AND KEEP FOR FUTURE REFERENCE

Name of Purchaser _____

Date of Purchase _____

Address _____

City _____ State _____ Zip Code _____

Telephone _____

Spa Model/Color _____

Spa Serial # _____

Pack Serial # _____

Dealer's Name _____

Dealer's Address _____

City _____ State _____ Zip Code _____

Telephone _____

Every effort has been made to ensure the accuracy of this manual. However, Marquis® reserves the right to improve its product without notice. This could create a minor variation between this manual and the actual product you receive. We apologize for any inconvenience this may cause.



- **IMPORTANT SAFETY INSTRUCTIONS**
 - 120V, Cord Connected Models 3
 - 240V, Permanently Installed or Converted Models4
 - All Spa Models 4-5
 - Personal Safety6-7

- **INSTALLATION INSTRUCTIONS**
 - Location 8-9
 - Filter Cartridges 10
 - Electrical Requirements 11-13

- **STARTING YOUR HOT TUB**..... 13-15

- **MARQUIS® HOT TUB MODELS**
 - Show™16-18
 - Epic™ 19-20
 - Euphoria™ 21-23
 - Wish™ 24-26
 - Reward™27-28
 - Resort™ 29-30
 - Promise™ 1-Pump..... 31-32
 - Promise™ 2-Pump..... 33
 - Spirit™ 34-35
 - Mirage™ 36-37
 - Rendezvous™ 38

- **MARQUIS® SPA CONTROL OPERATION**
 - All Models..... 39-45
 - Aroma Infusions..... 46
 - MicroSilk® 46-47
 - Adagio™ Audio System..... 47-48
 - Wi-Fi..... 48

- **MARQUIS® EQUIPMENT DIAGRAMS**
 - Mirage, Rendezvous, Spirit..... 49
 - Reward, Resort..... 50
 - Promise 1 & 2 Pump..... 51
 - Epic, Euphoria, Wish..... 51
 - Show..... 52

- **MARQUIS® TROUBLESHOOTING**
 - LCD Diagnostic Messages..... 53-55

- **MAINTENANCE ALL MODELS** 56-60

- **SPA CARE AND ENJOYMENT GUIDE ALL MODELS**..... 61-65

- **WATER TROUBLESHOOTING ALL MODELS**..... 66-69

- **DURAWOOD STEP ASSEMBLY INSTRUCTIONS**..... 70

- **MARQUIS® OWNER'S PROTECTION PLAN**..... 71-75

The following instructions contain important safety information. We strongly encourage you to read and apply them.

IMPORTANT SAFETY INSTRUCTIONS

WHEN INSTALLING AND USING THIS ELECTRICAL EQUIPMENT, BASIC SAFETY PRECAUTIONS SHOULD ALWAYS BE FOLLOWED, INCLUDING THE FOLLOWING:

1. READ AND FOLLOW ALL INSTRUCTIONS

2. **WARNING:** To reduce the risk of injury, do not permit children to use this product unless closely supervised at all times.
3. **DANGER: RISK OF CHILD DROWNING.** Extreme caution must be exercised to prevent unauthorized access by children. To avoid accidents, ensure that children cannot use the spa or hot tub unless they are supervised at all times.

120 VOLT, CORD CONNECTED MODELS

4. **DANGER: RISK OF INJURY.** Connect only to a grounded source.
5. Do not bury the power cord.
6. **WARNING:** To reduce the risk of electric shock, replace a damaged cord immediately.
7. A ground terminal (pressure wire connector) is provided on the surface of the control box inside the equipment compartment. This connector should be bonded with a minimum No. 8 AWG (8.42mm²) (No. 6 AWG in Canada) solid copper wire between this unit and any metal ladders, metal water pipes, metal enclosures of electrical equipment, conduit, or metal equipment within five feet (1.52m) of the spa. If the spa is located on a reinforced concrete pad, the reinforcing steel should also be bonded to the ground terminal.
8. **WARNING:** Your spa may be equipped with a Ground Fault Circuit Interrupter (GFCI) on the end of the power supply cord. Before each use of the spa, with the plug connected to the power supply and the unit operating, press the "test" button. The unit should stop operating and the GFCI power indicator will go out. Wait thirty seconds and then reset the GFCI by pressing the "Reset" button. The GFCI power indicator will turn on, restoring power to the spa. If the interrupter does not perform in this manner, it is an indication of an electrical malfunction and the possibility of an electric shock. Disconnect the plug from the receptacle until the fault has been identified and corrected.



240 VOLT, PERMANENTLY INSTALLED OR CONVERTED MODELS

9. A ground terminal is provided on the control box. To reduce the risk of electric shock, connect this terminal to the grounding terminal of your electrical service or supply panel with a continuous green, insulated copper wire. The wire must be equivalent in size to the circuit conductors supplying the equipment. In addition, a bonding terminal (pressure wire connector) is provided on the outside of the control box for bonding to local ground points. To reduce the risk of electric shock, this connector should be bonded with a No. 8 AWG (8.42mm²) (No. 6 AWG in Canada) solid copper wire to any metal ladders, water pipes, or other metal within five feet (1.52m) of the spa to comply with local requirements.
10. Your spa uses ground fault circuit interrupters in the electrical sub-panel. Before each use of the spa and with the unit operating press the Test button on each breaker. The switch should click over to the "Trip" position. Wait thirty seconds and reset each GFCI breaker by switching it completely off and then completely on. The switch should then stay on. If either of the interrupters does not perform in this manner, it is an indication of an electrical malfunction and the possibility of an electric shock. Disconnect the power until the fault has been identified and corrected.

ALL SPA MODELS

11. Install the spa so proper drainage is provided.
12. **DANGER: RISK OF ELECTRIC SHOCK.** Install the spa at least five feet (1.52m) away from metal surfaces, in accordance with the National Electric Code ANS/NMFA70-1993. Each metal surface must be permanently connected to a minimum No. 8 (8.42mm²) (No. 6 AWG in Canada) solid copper conductor attached to the wire bonding connector on the terminal box provided for this purpose.
13. **DANGER: RISK OF ELECTRIC SHOCK.** Do not permit any appliance, such as a light, telephone, radio, or television, etc. within five feet (1.52m) of the spa or hot tub.
14. **WARNING:** To reduce the risk of injury:
 - Water temperatures between 100°F (38°C) and 104°F (40°C) are considered safe for a healthy adult. Lower water temperatures are recommended for extended use (exceeding 10 minutes) and for young children.
 - Since excessive water temperatures have a high potential for causing fetal damage during the early months of pregnancy, pregnant or possibly pregnant women should limit spa water temperatures to 100°F (38°C).
 - Before entering a spa, the user should measure the water temperature with an accurate, waterproof, fever thermometer since the tolerance of temperature-regulating devices may vary as much as +/- 5°F (3°C).
 - The use of drugs, alcohol, or medication before or during spa use may lead to unconsciousness with the possibility of drowning.
 - Persons suffering from obesity or with a medical history of heart disease, low or high blood pressure, circulatory system problems, or diabetes should consult a physician before using the spa.



- Persons using medications should consult a physician before using a spa since some medication may induce drowsiness while other medication may affect heart rate, blood pressure, and circulation.
- 15. **DANGER: TO REDUCE THE RISK OF INJURY TO PERSONS.** Do not remove the suction fittings.
- 16. **DANGER: RISK OF INJURY:** Never operate a spa if the suction guard(s) is broken or missing. Never replace a suction guard with one rated less than the flow rate marked on the original suction guard. The suction guard(s) in the spa are sized to match the specific water flow created by the pump. Should the need arise to replace the suction guard(s) or the pump, be sure that the flow rates are compatible.
- 17. **DANGER:** Children are especially sensitive to hot water. At no time should children have unsupervised access to the spa. Children must not be allowed to climb onto the spa cover. All Marquis spas are equipped with a locking cover that meets the ASTM F1346-91 Standard for Safety Covers. Always lock the child resistant locks after using the spa for your children's safety.

18. **SAVE THESE INSTRUCTIONS.**

WARNING: Do not permit electric appliances (such as a light, telephone, radio, or television) within five feet (1.52m) of the spa or hot tub.

WARNING: Children should not use spas or hot tubs without adult supervision.

WARNING: Do not use spas or hot tubs unless all suction guard(s) are installed to prevent body and hair entrapment.

WARNING: Do not use drugs or alcohol before or during the use of a spa or hot tub to avoid unconsciousness and possible drowning.

WARNING: People using medications and/or having an adverse medical history should consult a physician before using a spa.

WARNING: The use of alcohol, drugs, and medication can greatly increase the risk of fatal hyperthermia.

WARNING: Before entering the spa or hot tub measure the water temperature with an accurate thermometer.

WARNING: Water temperature in excess of 104°F (40°C) may be injurious to your health.

WARNING: Prolonged immersion in a spa or hot tub may be injurious to your health.

WARNING: People with infectious diseases should not use a spa.

WARNING: Pregnant or possibly pregnant women should consult a physician before using a spa or hot tub.

WARNING: To avoid injury, exercise care when entering and exiting the spa or hot tub.

WARNING: Do not use a spa or hot tub immediately following strenuous exercise.

WARNING: Maintain water chemistry in accordance with manufacturer's instructions.

SAFETY INSTRUCTIONS FOR FRENCH SPEAKING SPA OWNERS

AVERTISSEMENT: Ne pas placer d'appareil électrique (luminaire, téléphone, radio, téléviseur, etc.) moins de 1.52 m de cette cuve de relaxation.

AVERTISSEMENT: Ne pas laisser les enfants utiliser une cuve de relaxation sans surveillance.

AVERTISSEMENT: Pour éviter que les cheveux ou une partie du corps puissent être aspirés, ne pas utiliser une cuve de relaxation si les grilles de prise d'aspiration ne sont pas toutes en place.

AVERTISSEMENT: Pour éviter l'évanouissement et la noyade éventuelle, ne prendre ni drogue ni alcool avant d'utiliser une cuve de relaxation ni quand on s'y trouve.

AVERTISSEMENT: Les personnes qui prennent des médicaments ou ont des problèmes de santé devraient consulter un médecin avant d'utiliser une cuve de relaxation.

AVERTISSEMENT: La consommation d'alcool ou de drogue augmente considérablement les risques d'hyperthermie mortelle dans une cuve de relaxation.

AVERTISSEMENT: Avant d'utiliser une cuve de relaxation mesurer la température de l'eau l'aide d'un thermomètre précis.

AVERTISSEMENT: Il peut être dangereux pour la santé de se plonger dans de l'eau plus de 40°C.

AVERTISSEMENT: L'utilisation prolongée d'une cuve de relaxation peut être dangereuse pour la santé.

AVERTISSEMENT: Les personnes atteintes de maladies infectieuses ne devraient pas utiliser une cuve de relaxation.

AVERTISSEMENT: Les femmes enceintes, que leur grossesse soit confirmée ou non, devraient consulter un médecin avant d'utiliser une cuve de relaxation.

AVERTISSEMENT: Pour éviter des blessures, user de prudence en entrant dans une cuve de relaxation et en sortant.

AVERTISSEMENT: Ne pas utiliser une cuve de relaxation immédiatement après un exercice fatigant.

ATTENTION: La teneur de l'eau en matières dissoutes doit être conforme aux directives du fabricant.

PERSONAL SAFETY

Prolonged immersion in hot water can result in **HYPERTHERMIA**, a dangerous condition which occurs when the internal temperature of the body reaches a level above normal (98.6°F, 37°C). The symptoms of hyperthermia include dizziness, fainting, drowsiness, lethargy, and a body temperature above 98.6°F (37°C). The physical effects of hyperthermia include unawareness of impending hazard, failure to perceive heat, failure to recognize the need to exit the spa, physical inability to exit the spa, fetal damage in pregnant women, and unconsciousness resulting in a danger of drowning.

Other booklets about spa safety are: “Children Aren’t Waterproof,” “Pool and Spa Emergency Procedures For Infants and Children,” “Layers of Protection” and “The Sensible Way to Enjoy Your Spa” published by Association of Pool & Spa Professionals.

WARNING: The use of alcohol, drugs, or medication can greatly increase the risk of fatal hyperthermia in hot tubs and spas.

Persons taking medications which induce drowsiness such as tranquilizers, antihistamines, or anticoagulants should not use the spa. Pregnant women and persons with a medical history of heart disease, diabetes, or high blood pressure should consult a physician before using the spa.

PERSONAL SAFETY DOs:

- Be sure your spa is connected to the power supply correctly – only use a licensed electrical contractor.
- Shut off power supply (unplug 120V models) before draining the spa or servicing the electrical components.
- Test the Ground Fault Circuit Interrupter (GFCI) monthly.
- Always test the water temperature with an accurate thermometer before entering the spa to be sure that it’s a safe temperature.
- Do not use the spa if water temperature is outside of set temperature. Remember that wet surfaces can be very slippery. Take care when entering and exiting the spa.
- Lock the DuraCover™ when the spa is not in use, whether it is empty or full of water.
- Keep the water clean and sanitized with correct chemical care.
- Turn on the jets when adding ANY chemicals to the spa water.
- Clean the filter cartridge(s) monthly to remove debris and mineral buildup which affects the performance of the hydrotherapy jets, limits the flow, or trips the high limit thermostat which will turn off the entire spa.

PERSONAL SAFETY DO NOTs:

- Don’t use the spa with the equipment compartment door removed.
- Don’t use the spa for more than 10 minutes of time at water temperatures in excess of 102°F (39°C).
- Don’t allow the jet pump(s) to operate for an extended period of time with the cover in place. Extended pump operation causes a slow heat buildup due to water friction. The spa equipment controls are equipped with a built-in safety timer that automatically shuts off the jet pump(s) after 15 minutes of continuous operation should it have been left on inadvertently.
- Don’t operate the spa at any time with the filter cartridges removed.
- Don’t lift or drag the cover by using the tie-down straps; always lift and carry by using the external handles.
- Don’t store chemicals in the spa’s equipment compartment.
- Don’t hesitate to call your authorized dealer with any questions or maintenance concerns.

LOCATION

For your portable spa to function properly and safely, it must be located on a hard, flat, level surface. Inground spas require special installation techniques and should be planned in conjunction with your authorized Marquis® dealer. Improper installation can result in structural damage to the spa and the voiding of your spa warranty. Items to discuss with your dealer include: Local construction codes, electrical service requirements, serviceability of equipment present underground obstructions such as gas, water, and telephone lines, safety measures such as fences and locks, and visibility of the spa installation from the home, street, and neighbors.

Do not shim your spa. If your pad is not level you must pour a top cap: contact a professional.

- Allow for sufficient water drainage around the spa to help preserve the equipment and support structure. This includes indoor installations.
- A filled spa can weigh up to 5,000 pounds and the location should support the weight of the filled spa.
- Locate the equipment compartment where it will be accessible. Your spa **MUST** be installed to permit access for servicing the equipment above and/or below any decks or floors. Access is essential and must allow adequate room for service. To facilitate repairs, Marquis Corp. or its agent may require access to spa equipment. It is your responsibility to provide unencumbered access. See spa diagrams for location of power supply.
- Leave access to the circuit breakers in the sub panel (240V models) or to the interrupter switch (GFCI, 120V models) on the end of the power cord.
- Be sure the spa is level and in the final position **BEFORE** filling with water. Check for power cords, tools, and hoses that may be caught underneath the spa. Do not apply power to the spa before it is completely filled with water. Damage to the pumps, heater and sensors may result.
- **IMPORTANT: DO NOT LET AN EMPTY SPA REMAIN EXPOSED TO DIRECT SUNLIGHT.**

Spa surface temperatures can reach in excess of 180°F (82°C) if left exposed to the sun. Significant damage can occur to the acrylic if this is allowed to happen, including warping and blistering of the surface. Damage, that occurs as a result of this exposure, is not covered under the warranty.

- **CAUTION:** Never try to move a spa that has not been fully drained. To do so could result in damage to the spa and physical injury to the mover. Cracks in the spa surface, exterior siding or DuraBase due to improper transport or support of the spa are not covered under the warranty.

OUTDOOR AND PATIO INSTALLATION

To install the spa outdoors, we recommend a reinforced concrete pad at least four inches thick. The reinforcing material should be attached to a #8 AWG bonding wire per national and local electrical code.

If you place the spa on the ground, even temporarily, place the spa empty of water on concrete pavers under the entire bottom of the spa. The concrete pavers should be a least two inches thick and level across the entire surface. The spa will inevitably settle and not remain level on this surface, thus it's important to get the spa onto a solid foundation as soon as possible.

INSTRUCTIONS FOR PREFABRICATED SPA PADS

If you are using a prefabricated spa pad for a foundation, please use the following guidelines:

1. Designate the area where the spa is to be installed. Please make sure the ground is flat and level.
2. Using 2"x 6" (51mm - 152mm) weather resistant lumber and 3" (76mm) outdoor deck screws, build a frame large enough for the prefabricated spa pad to fit inside with minimum 1" (25mm) clearance on all sides.
3. Install the frame in the area that has been leveled.
4. Using crushed gravel, fill the frame to the top.
5. Lay a straight piece of lumber across the frame and level any high spots in the gravel by pushing the straight lumber across the frame. Fill in any low areas with more gravel and re-level using the straight piece of lumber.
6. Compact the gravel to make the surface is hard and flat. You may need to add more gravel to bring the level back up to the top of the frame. If so, please re-level and re-compact until you have a hard, flat level surface that is even with the top of the frame.
7. Place the prefabricated spa pad on top of the gravel. Please be careful not to disturb the hard, flat, level surface.
8. Please make sure no portion of the spa pad is sitting outside or on top of the framing.
9. Place the spa on top of the pad and fill the spa with water.

DECK INSTALLATION

Be sure the deck can support the weight of your filled spa by checking the deck's maximum load capacity. Consult a qualified building contractor or structural engineer. Minimum requirement is 100 lbs. (45 kg) per square foot.

INDOOR INSTALLATION

There are special requirements if you place your spa indoors. Flooring material must provide adequate traction when wet. Proper drainage is essential to prevent water puddling. Proper ventilation to the area is required. The addition of a ventilation system is recommended. Please see your contractor for details.



Shut-off valve in
open position

SHUT-OFF VALVES

Your spa is equipped with shut-off valves (see EQUIPMENT DIAGRAM) that shut off the water flow to the equipment system for authorized Marquis® dealer service. At times, a new spa or one that has recently been serviced, may have the shut-off valves partially closed which can restrict the water flow and hinder jet performance. Be sure the valves are fully open.

FREEZE PROTECTION

When a freeze condition is detected (which occurs when the temperature in the heater housing drops to 55°F, (13°C) the jet pump(s) is automatically activated. In areas with extremely cold winter conditions, your spa should be fine as long as it is left running at normal operating temperatures. For extra protection see your dealer for an optional freeze sensor. If you plan to turn the spa off, follow the instructions in this manual (see SUSPENDED USE OR WINTERIZING YOUR SPA).

OVERHEATING

In the case of extended hot weather, the spa water temperature may reach and maintain 104°F to 106°F (40°C to 41°C) or higher. This is due to the ambient temperature and the full insulation in the spa cabinet. You have the option of changing when or how long the pumps will run. See SPA CONTROL OPERATION for available options.

FILTER CARTRIDGES

Your portable spa is equipped with the Constant-Clean™ Filtration system. It features one or two Vortex filters.

NOTE: It is very important that the components of these filtration systems be installed properly in the proper part of the spa.

1. Hold the Vortex filter cartridge and center it in the opening of the filter housing.
2. Use the filter handle and turn the filter cartridge clockwise to screw it in place. (Use caution not to overtighten as damage may occur to threads and is not covered under warranty.)
3. Grasp the edge of the Vortex skimmer lid or Waterfall, center it over the rings and gently snap in place.
4. Replace the filter cover.

SUCTION GUARDS

The suction guard(s) in the footwell of your spa is an opening through which the jet pump(s) draws water. The suction fittings have an integrated vacuum release built into them. In the event that a suction fitting gets blocked, air will be induced causing the pump to cavitate and the water flow interrupted. Once the blockage is removed, normal operation will resume. Suction fittings are equipped with a safety guard. Suction through the fittings can be strong. The safety guard(s) must remain in place and undamaged. A fitting with a damaged guard(s) can be dangerous, especially to small children or people with long hair. Should any part of the body become drawn to a fitting, turn the jet pump(s) off immediately. Long hair should be restrained. Never allow long hair to float freely in the spa. Replace any missing or damaged suction guard(s).



Safety guard of suction fitting must remain in place.

NOTE: It is normal for the flow rates of the suction fittings to vary from strong to barely noticeable.

ELECTRICAL REQUIREMENTS

It is the responsibility of the spa owner to ensure that all electrical connections are made by a qualified electrician in accordance with all national, state, and local electrical codes in effect at the time of installation. Fuses are covered to be free of defect at time of installation only.

NOTE: e-Series™ hot tubs have different components. Please see the proper wiring in the e-Series™ section of this manual.

240 Volt

All connections must be made in accordance with the wiring diagram found on the inside of the control box cover. Connections must be made with copper conductors only – *do NOT use aluminum wire*. All conductors, circuit breakers, and fuses and the GFCI must be sized in accordance to the total amperage load as specified below.

Improperly wired spas can cause irreversible damage resulting in blown fuse and melted terminal block, and to other electrical components. Also, damage caused to components or equipment caused by high or low voltage, brown outs or electric surges is not covered under warranty.

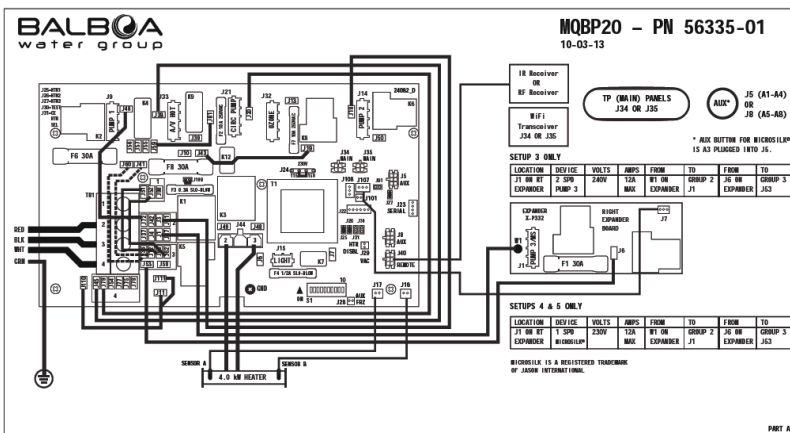

- Permanently connected (Hard wired).
- Rated 240V, 60Hz, 50A, three wires (#6 copper) plus ground (#8 copper (8.42mm²)), [4 wires total].
- Circuit breaker or fuse size: 50A.
- A disconnecting means must be installed within sight from the equipment and at least 5 feet (1.52m) from the inside walls of the spa.
- Connect only to a circuit protected by a Class A ground Fault Circuit Interrupter (GFCI).

120 Volt

120 Volt spas shall be plugged into a properly grounded, grounding type 15 amp receptacle on a dedicated circuit. A dedicated circuit is a circuit with no other components that consume power, such as lights, televisions, radios, computers, or other electronic devices. These could cause your spa to malfunction by any of the following: unusual text on the control panel, slow heating, poor jet action, tripping house breaker, or blown fuses. Failure to follow these instructions could lead to premature failure of spa components that would not be covered under the warranty. The dedicated circuit shall meet the following specifications:

- Rated 120V, 60Hz, 15A (2 wires plus ground)
- Circuit breaker or fuse size: 15A
- The receptacle must be at least 5 feet (1.52 m) from the spa.
- The 15 foot GFCI power cord provided with the spa must be plugged directly into the receptacle. Do NOT use an extension cord or any other adaptor. Actual exposed length of cord will vary by model, but will never be less than 12 feet.

Convert 120 Volt to 240 Volt

120 Volt spas may be converted to operate on 240V, 50A. Wiring must be performed by a licensed electrician in accordance with the NEC and any local or regional electric codes.

1. Disconnect the power: Unplug GFCI cord from wall receptacle. Disconnect cord end from terminal block and ground bar inside equipment box.
2. Move white jumpers on J24 to connect the two middle pins only. Failure to do this will result in a blown transformer.
3. For 50 amp operation Move dip switch #2 up to the on position. This will allow the heater to operate on pump 1 high speed. Install 240V power as indicated on the 240V section.
4. Remove the jumper wire connecting J75 to J47 and discard.
5. Reconnect the spa with 240V power to approved GFCI and exterior mounted disconnect.

Red (hot) wire connected to #2 on terminal block.
 Black (hot) wire connected to #3 on terminal block.
 White (neutral) wire connected to #4 on terminal block.

Green (ground) wire routed through plastic enclosure and secured to exterior bonding lug.

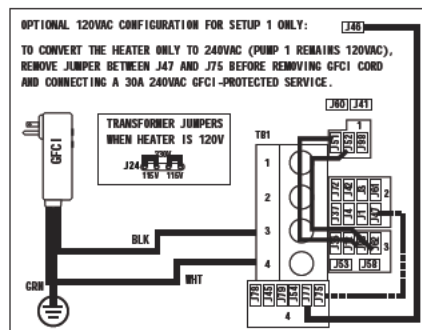

Improperly wired spas are beyond Marquis Corp. control and are not covered under the warranty. Other items beyond Marquis Corp. control include, but are not limited to, damage resulting from: improper connections; accidents; failure to follow procedures and instructions defined in the Marquis® printed instructions; cleaning agents; and natural occurrences including but not limited to rodent or insect infestation, mold, lightning and other acts of nature.

STARTUP PROCEDURE

Your spa is equipped with solid-state Comfort Controls specific to your spa model. (See **SPA CONTROL OPERATION** for your specific spa model.)

NOTE: Your spa has been filled and test-run at the factory. The first time your spa is filled with water, some discoloration from residual test water may appear. This will disappear when the spa is completely filled and the filtration system is functioning.

THERAPY PUMP(S)

Startup procedure for all models

1. Place spa on a hard, flat, level surface. Make sure the power supply is off.
2. Make sure the suction guard(s) in the footwell are in place and undamaged.
3. Open the equipment door. Tighten all disconnects and open all shut-off valves.

NOTE: Keep the drain valve closed at all times except when draining the spa (do not rely on the cap to stop the flow of water). Not doing so could result in damage to the drain valve due to freezing water.

4. Install filter cartridges. (See **INSTALLATION INSTRUCTIONS**, Filter Cartridges.)
5. Fill the spa with water to two-thirds of the way up the Vortex skimmer openings. The use of a *Fill Filter* is recommended, especially in areas with high mineral content in the water.
6. Turn the power on.

WARNING: Spa must be completely filled with water before turning on power.

7. Your spa is now in “pump priming” mode and a “Priming Mode” message displays in the LCD window of the control panel. While in this mode the spa appears idle, which lasts approximately four to five minutes if not exited manually. To exit manually, press the BACK/SET pad.
8. Allow the spa to circulate on high-speed (see **SPA CONTROL OPERATION**) for four to five minutes to discharge air from the plumbing system. Do not expect hot water immediately from the jets; the heater will take several hours to heat the water.

(Continued next page)



Vent air by slightly opening pump unions.

9. At this time the spa should have water flowing from the jets. If the pump has not primed and the water is not flowing from the jets after two minutes **TURN OFF POWER TO THE SPA** and vent air from the pumps by slightly opening the pump unions located behind the equipment door. After turning the power on again, the spa initiates a new priming mode. Repeat steps above.
10. The system requires approximately two minutes of water flow to determine the water temperature. After two minutes of water flow, the temperature is displayed as actual water temperature. After you have manually exited the priming mode (or allowed the spa to automatically exit) the LCD window momentarily displays 100°F (38°C) and then the display switches to - - °F.
11. The factory default setting for water temperature is 100°F (38°C). Use the TEMP pads on the control panel to set the water temperature to the desired level. (See SPA CONTROL OPERATION.) It takes up to 24 hours to heat the water to desired temperature depending on the water temperature and voltage of your spa.
12. If water is not coming out of the jets, check to make sure the adjustable jets are open. Simply turn the jet face to open or close the jets.

Test the water for the proper chemical balance and adjust as necessary. Marquis® SpaCare products are recommended. (See **WATER TREATMENT**.) **PROPER CHEMICAL BALANCE IS IMPORTANT** for your safety and the longevity of your spa.

DURACOVER™

When the spa is not in use, the DuraCover should be kept on the spa to retain the water's heat and to keep out dirt, leaves, etc.

For your safety and convenience, the cover is equipped with adjustable straps, safety locks, and handles. Use the exterior handles to remove and replace your cover after breaking the vacuum seal with one hand. Never attempt to open or remove the cover by grasping or pulling on the cover skirting or cover lock straps as the skirting will tear.

Marquis® suggests you use the safety locks to help keep out unintended users, prevent covers from being blown off in windy conditions and to maximize heat retention/energy efficiency. The cover and retractable cover system are not recommended for use in wind conditions reaching above 25 miles per hour. If your spa is located in an area susceptible to high winds, additional Hold-Down wind straps may be necessary to minimize cover damage.

NOTE: Marquis® exclusive DuraCover is designed for optimum protection of the spa shell. Using an aftermarket cover will not provide the same protection and will void the shell warranty.

Open the spa cover:

1. Unfasten all cover lock straps.
2. Place one hand under the cover skirting, between the spa and cover, to break the cover's vacuum seal. Do not use cover handles to break vacuum seal.
3. Fold the front half of the cover over onto the back half.

NOTE: Unlock and release all cover locks before attempting to open cover. Damage caused by attempting to open the cover while locked or by wind is not covered under warranty. Do not walk, stand, climb, or sit on the vinyl cover or retractable cover system. Do not use hard, sharp, or metal objects, such as a windshield scraper, to remove ice. Such objects can cut, mar, or puncture the cover's vinyl surface.

Close the spa cover:

1. Slide folded cover onto one half of spa.
2. Unfold the cover by lifting the handle located on the top (front) half of the cover. Allow the unfolded half to gently drop down onto the spa.
3. Secure the cover lock straps to the spa and lock them.

NOTE: When opening a cover with a cover removal mechanism, use one of the manufacturer's recommended methods. Do not attempt to open the cover in any other way. Damage caused by improper opening or closing of the cover is not covered under the warranty.

Fading, staining, torn stitching of the spa cover and broken foam cores are not covered under the warranty for any reason. Spa covers do not qualify for labor coverage under the warranty. These parts may be purchased or exchanged under warranty at your authorized Marquis® dealer.

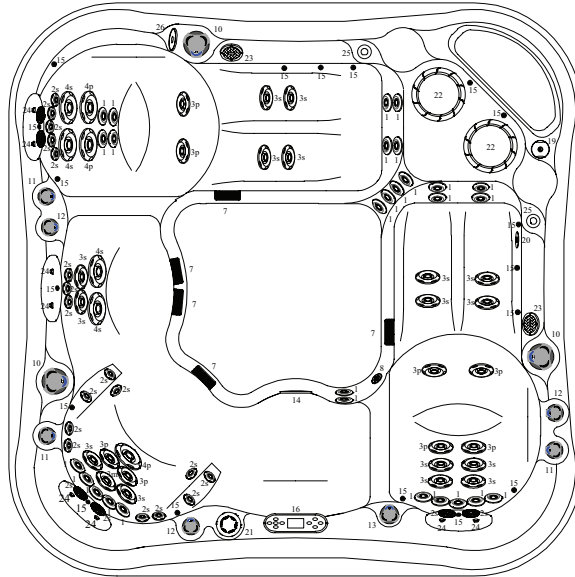

#	Component Identification	Qty.
1	HK™40 Jets	26
2s	HK™8 Jets Straight	24
3s	HK™12 Jets Straight	16
3p	HK™12 Jets Spin	8
3m	HK™12 Jets Multi-port	1
4s	HK™16 Jets Straight	4
4p	HK™16 Jets Spin	3
7	Suction Fittings	5
8	Floor Drain	1
10	Tri-Zone Controls	3
11	Neck Jet Valves	3
12	Air Controls	3
13	Waterfall Valve	1
14	Light	1
15	Constellation™ Lighting (option)	18
16	Bather's Control Panel	1
19	Aroma Infusions (optional)	1
20	Aroma Injector (optional)	1
21	In-Line Dispenser	1
22	Filter Canisters	2
23	Speakers	2
25	Headrest Buttons	8
26	Waterfall Features	2
27	Pump 3 Control	1

Physical Specifications	US/CAN	INTL
Dimensions	90" x 94"	229 x 239 cm
Height	35"	89cm
Corner Radius	17"	43cm
Seating Capacity/Positions	5/5	5/5
Weight Dry	1100 lbs	499 kg
Weight Full	5062 lbs	2296 kg
Water Capacity	475 gal	1798 l
Total Therapy Jets	82	82

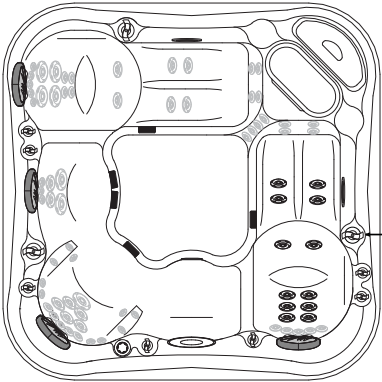

ZONE 1A (JETS 1)
Adirondack A: all back, hips, legs
and feet

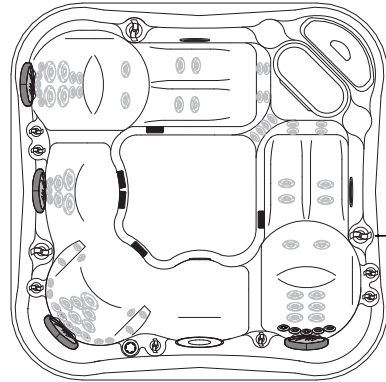

ZONE 2A (JETS 1)
Adirondack A: upper-back

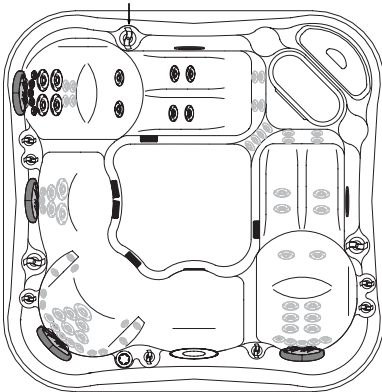

ZONE 1B (JETS 2)
Adirondack B: upper- and mid-
back, hips and feet

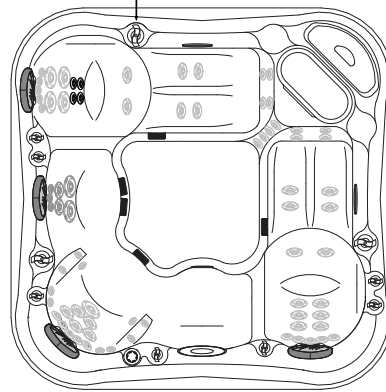

ZONE 2B (JETS 2)
Adirondack B: lower-back

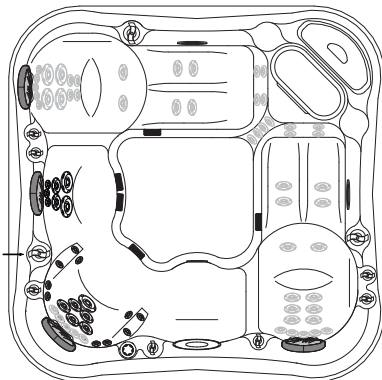

ZONE 1C (JETS 3)
Captain's chair: mid- and lower-
back, arms, knees and wrists. Seat:
all back

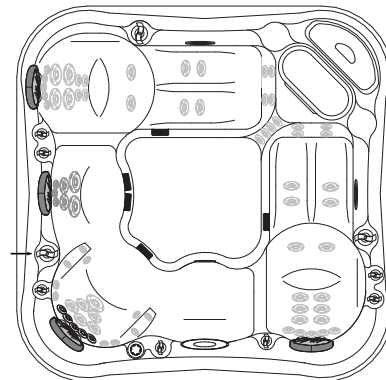

ZONE 2C (JETS 3)
Captain's chair: upper-back

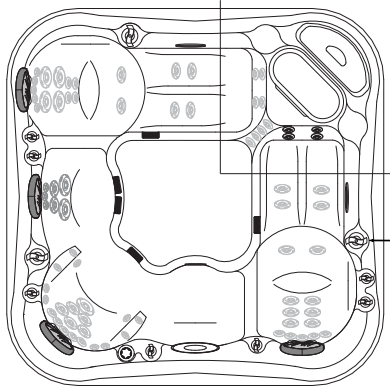

ZONE 3A (JETS 1)
Adirondack A: feet

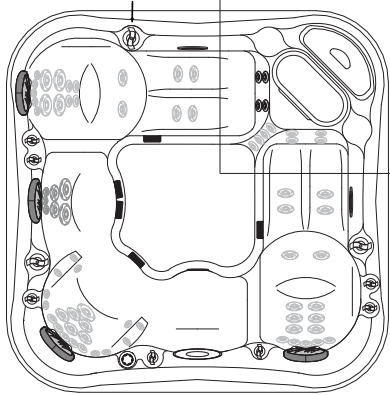

ZONE 3B (JETS 2)
Adirondack B: feet

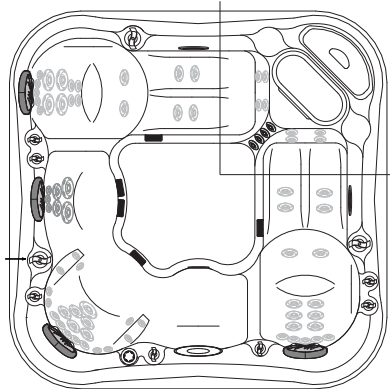

ZONE 3C (JETS 3)
Therapy pillar: legs and feet

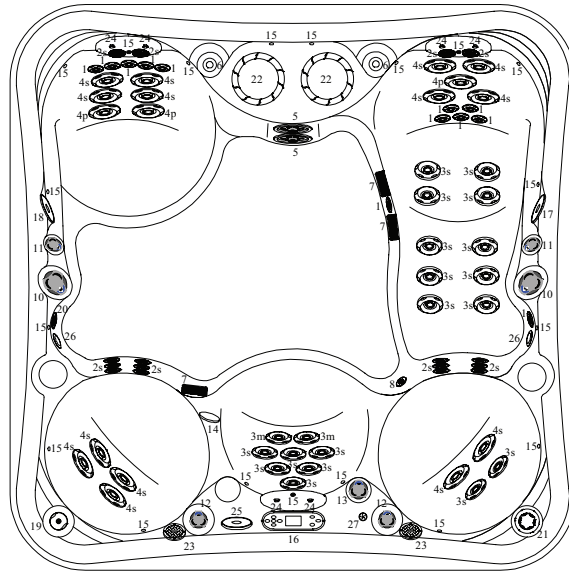

#	Component Identification	Qty.		
1	HK™40 Jets	10		
2s	HK™8 Jets Straight	16		
3s	HK™12 Jets Straight	18		
3m	HK™12 Jets Multi-port	2		
4s	HK™16 Jets Straight	14		
4p	HK™16 Jets Spin	3		
5	Geyser Jets	2		
6	Waterfall Features	2		
7	Suction Fittings	3		
8	Floor Drain	1		
10	Tri-Zone Controls	2		
11	Neck Jet Valves	2		
12	Air Controls	2		
13	Waterfall Valve	1		
14	Light	1		
15	Constellation™ Lighting (option)	19		
16	Bather's Control Panel	1		
17	Pump 1 control	1		
18	Pump 2 Control	1		
19	Aroma Infusions (optional)	1		
20	Aroma Injector (optional)	1		
21	In-Line Dispenser	1		
22	Filter Canisters	2		
23	Speakers	2		
24	Headrest Buttons	6		
25	MicroSilk® Pump 3	1		
26	MicroSilk® Return Fittings (optional)	2		
27	MicroSilk® Air Intake Fitting (optional)	1		
Physical Specifications		US/CAN	INTL	
	Dimensions	90" x 90"	229 x 229 cm	
	Height	35"	89 cm	
	Corner Radius	12"	30 cm	
	Seating Capacity/Positions	5/6	5/6	
	Weight Dry	850 lbs	386 kg	
	Weight Full	4603 lbs	2088 kg	
	Water Capacity	450 gal	1703 l	
	Total Therapy Jets	65	65	



ZONE 1 A

Upper- mid- and lower-back jets*

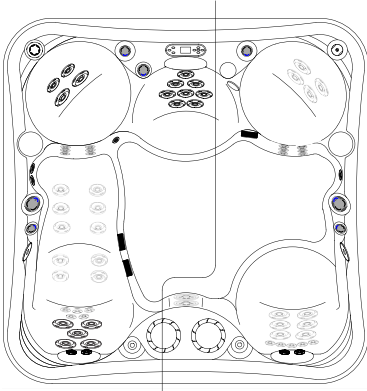

ZONE 2 A

Upper- mid- lower-back, foot jets*

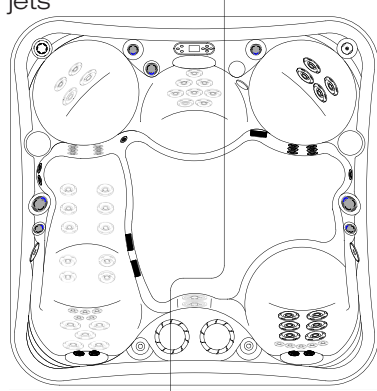

ZONE 1 B

H.O.T. Zone lumbar lounge*

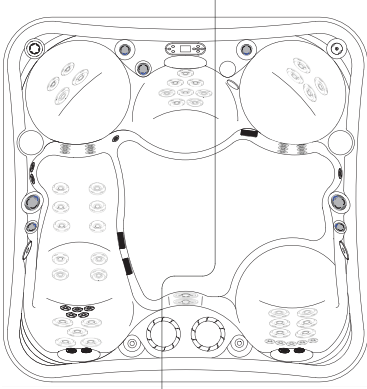

ZONE 2 B

H.O.T. Zone shoulder*

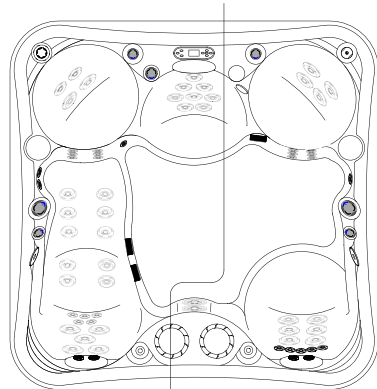

ZONE 1 C

Lounge leg and foot jets*

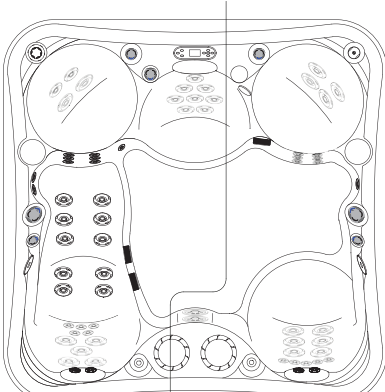

ZONE 2 C

Geyer Jets*

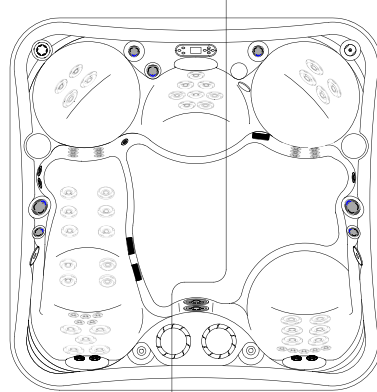

*HK8 neck jets operate in every zone20

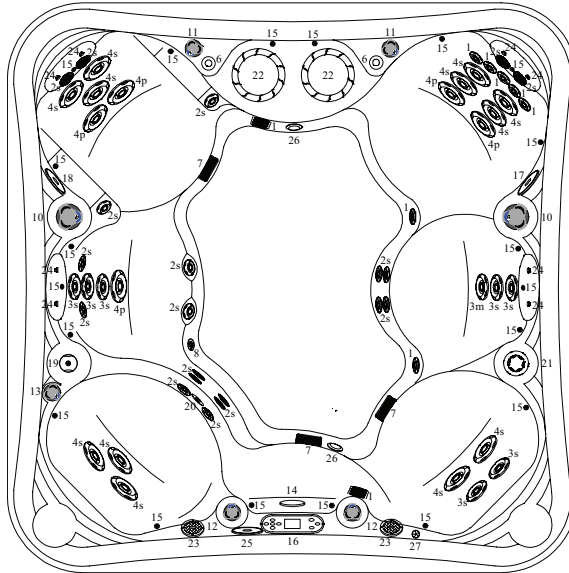

#	Component Identification	Qty.	
1	HK™40 Jets	13	
2s	HK™8 Jets Straight	20	
3s	HK™12 Jets Straight	7	
3m	HK™12 Jets Multi-port	1	
4s	HK™16 Jets Straight	12	
4p	HK™16 Jets Spin	5	
6	Waterfall Features	2	
7	Suction Fittings	3	
8	Floor Drain	1	
10	Tri-Zone Controls	2	
11	Neck Jet Valves	2	
12	Air Controls	2	
13	Waterfall Valve	1	
14	Light	1	
15	Constellation™ Lighting (option)	20	
16	Bather's Control Panel	1	
17	Pump 1 control	1	
18	Pump 2 Control	1	
19	Aroma Infusions (optional)	1	
20	Aroma Injector (optional)	1	
21	In-Line Dispenser	1	
22	Filter Canisters	2	
23	Speakers	2	
24	Headrest Buttons	8	
25	MicroSilk® Pump 3	1	
26	MicroSilk® Return Fittings (optional)	2	
27	MicroSilk® Air Intake Fitting (optional)	1	
Physical Specifications		US/CAN	INTL
Dimensions		90" x 90"	229 x 229 cm
Height		35"	89 cm
Corner Radius		12"	30 cm
Seating Capacity/Positions		7/7	7/7
Weight Dry		825 lbs	374 kg
Weight Full		4161 lbs	1887 kg
Water Capacity		400 gal	1514 l
Total Therapy Jets		58	58

ZONE 1A

Mid- and lower-back jets

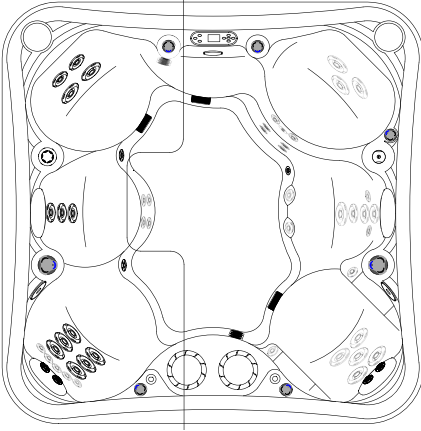

ZONE 1C

Whirlpool jets

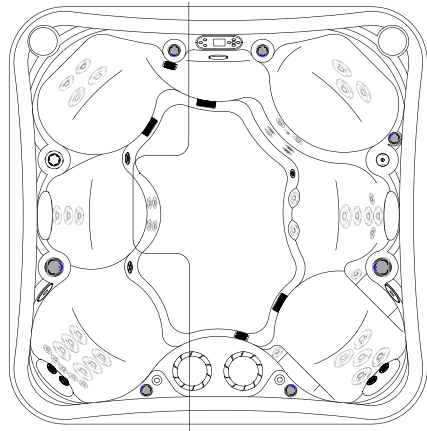

ZONE 1B

Upper-back jets

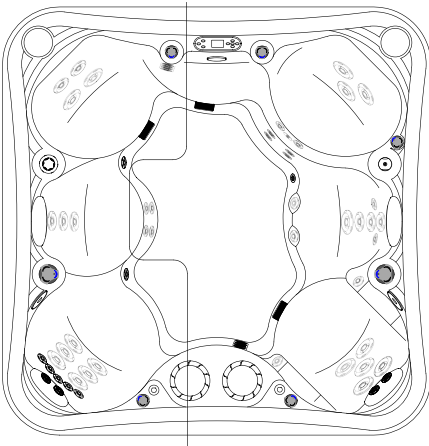



ZONE 2A

Leg, wrist, upper- and mid-back jets

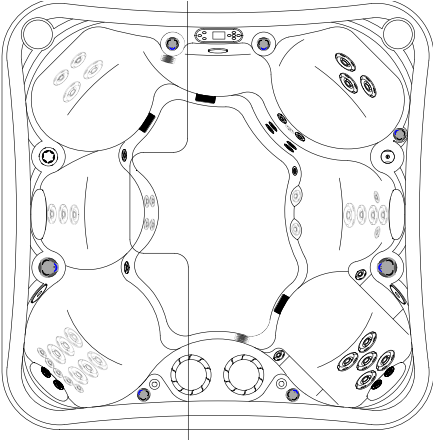

ZONE 2C

Whirlpool jets

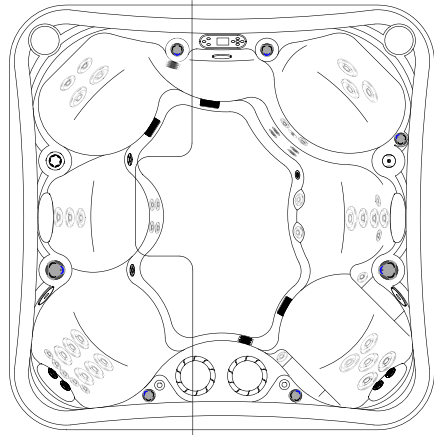

ZONE 2B

Leg, upper-, mid-, lower-back jets

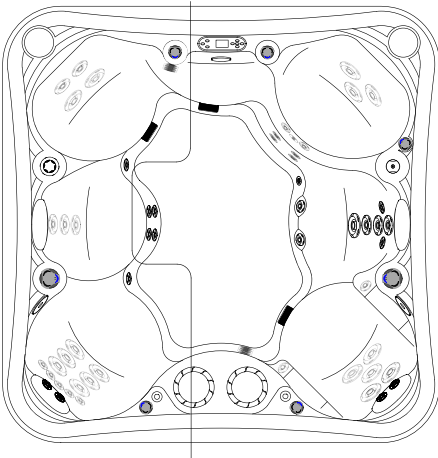

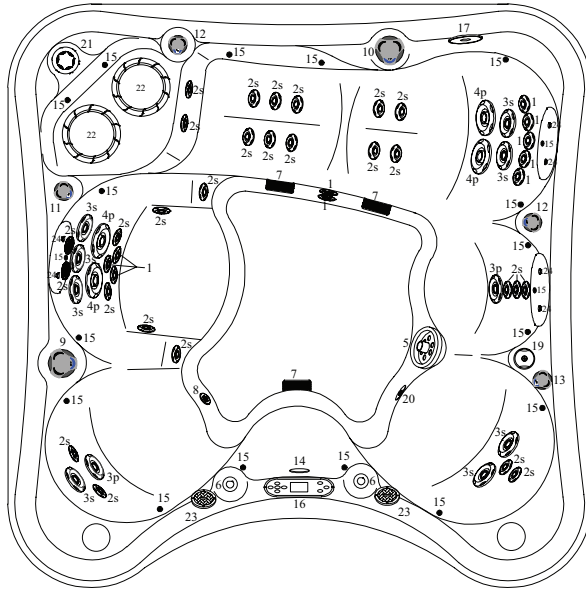

#	Component Identification	Qty.
1	HK™40 Jets	8
2s	HK™8 Jets Straight	27
3s	HK™12 Jets Straight	8
3p	HK™12 Jets Spin	2
4p	HK™16 Jets Spin	4
5	Geyser Jet	1
6	Waterfall Features	2
7	Suction Fittings	3
8	Floor Drain	1
9	2-Way Jet Selector	1
10	Tri-Zone Controls	1
11	Neck Jet Valves	1
12	Air Controls	2
13	Waterfall Valve	1
14	Light	1
15	Constellation™ Lighting (option)	19
16	Bather's Control Panel	1
17	Pump 1 control	1
19	Aroma Infusions (optional)	1
20	Aroma Injector (optional)	1
21	In-Line Dispenser	1
22	Filter Canisters	2
23	Speakers	2
24	Headrest Buttons	6
Physical Specifications		US/CAN INTL
Dimensions	84" x 84"	213 x 213 cm
Height	35"	89 cm
Corner Radius	12"	30 cm
Seating Capacity/Positions	5/5	5/5
Weight Dry	785 lbs	356 kg
Weight Full	3621 lbs	1642 kg
Water Capacity	340 gal	1287 l
Total Therapy Jets	50	50



WISH™ THERAPY CONTROL

ZONE 1A

Lounge leg and foot jets

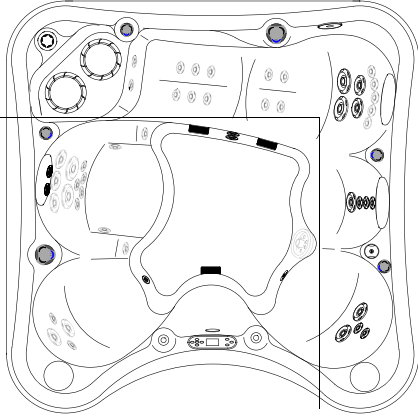

ZONE 1C

Lounge upper-back jets

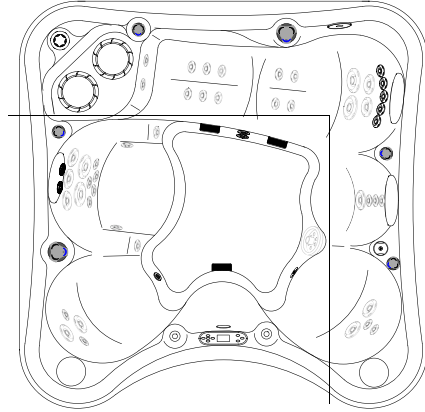

ZONE 1B

Upper-, mid-, and lower-back jets

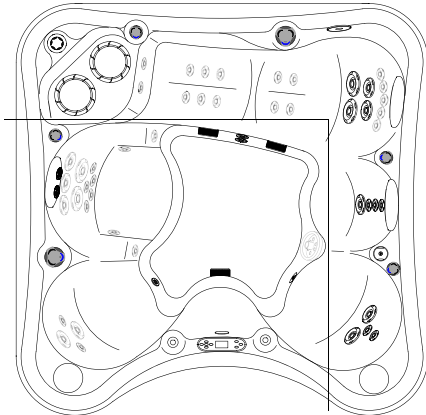



ZONE 2 (JETS 1)

Upper- and mid-back jets

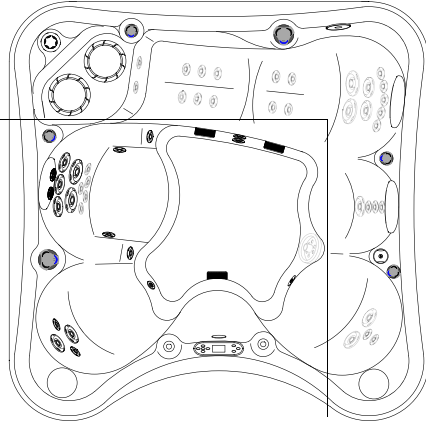

ZONE 2 (JETS 2)

Lower-back and Geyser jets

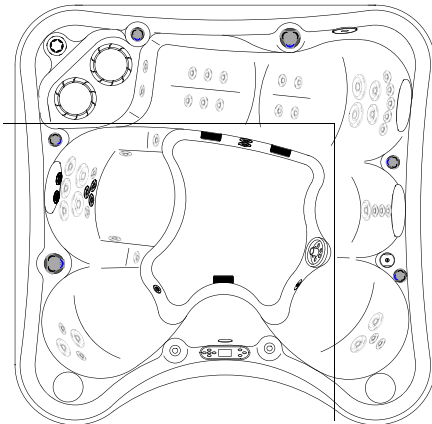

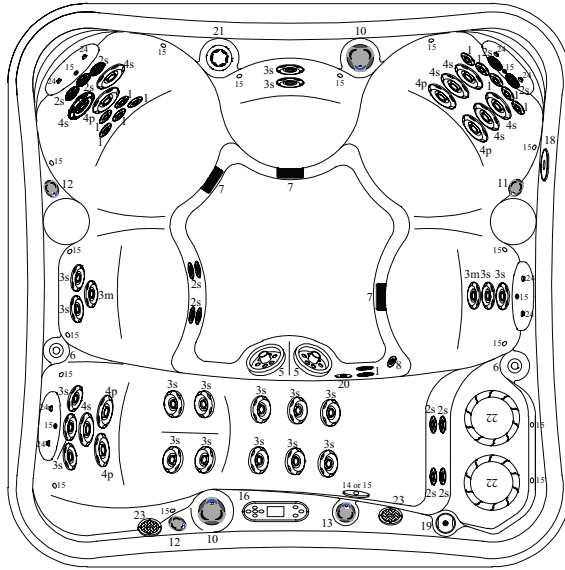

#	Component Identification	Qty.	
1	HK™40 Jets	11	
2s	HK™8 Jets Straight	13	
3s	HK™12 Jets Straight	19	
3m	HK™12 Jets Multi-port	2	
4s	HK™16 Jets Straight	7	
4p	HK™16 Jets Spin	4	
5	Geyser Jets	2	
6	Waterfall Features	2	
7	Suction Fittings	3	
8	Floor Drain	1	
10	Tri-Zone Controls	2	
11	Neck Jet Valves	1	
12	Air Controls	2	
13	Waterfall Valve	1	
14	Light	1	
15	Constellation™ Lighting (option)	20	
16	Bather's Control Panel	1	
17	Pump 2 control	1	
19	Aroma Infusions (optional)	1	
20	Aroma Injector (optional)	1	
21	In-Line Dispenser	1	
22	Filter Canisters	2	
23	Speakers	2	
24	Headrest Buttons	8	
Physical Specifications		US/CAN	INTL
Dimensions		85.5" x 85.5"	217 x 217 cm
Height		35"	89 cm
Corner Radius		12"	30 cm
Seating Capacity/Positions		6/6	6/6
Weight Dry		795 lbs	361 kg
Weight Full		3659 lbs	1660 kg
Water Capacity		350 gal	1325 l
Total Therapy Jets		58	58



ZONE 1A: All back jets in lounge and side seats, plus footwell

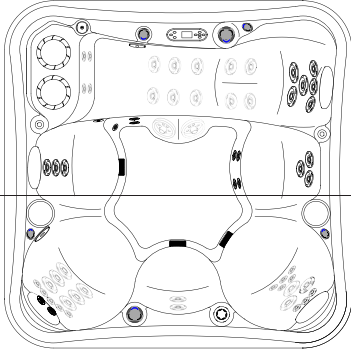

ZONE 2A: Back jets in therapy seats and side seat

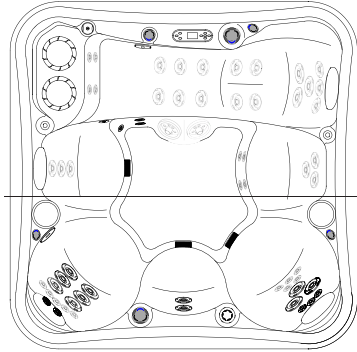

ZONE 1B: Lounge leg, foot jets

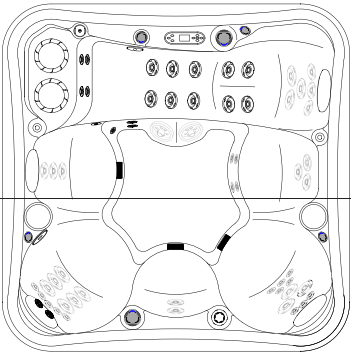

ZONE 2B: Lower back jets in therapy seat

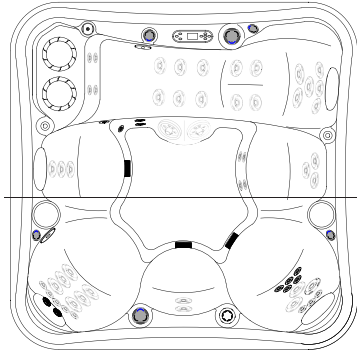

ZONE 1C: Dual geyser jets in footwell

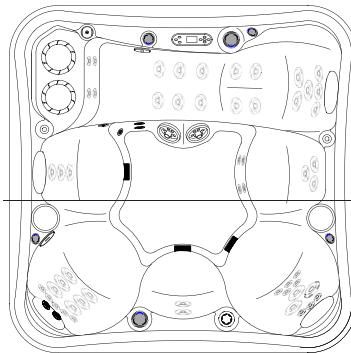

ZONE 2C: Upper back jets in therapy seat

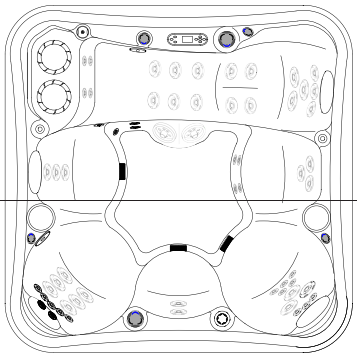

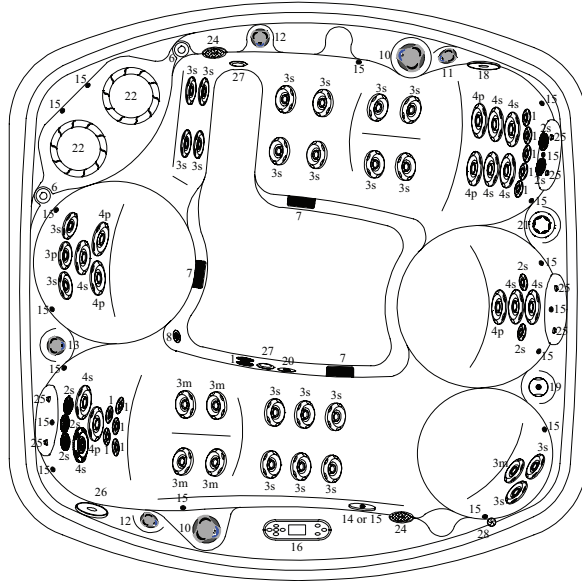

#	Component Identification	Qty.		
1	HK™40 Jets	10		
2s	HK™8 Jets Straight	7		
3s	HK™12 Jets Straight	22		
3m	HK™12 Jets Multi-port	5		
3p	HK™12 Jets Spin	1		
4s	HK™16 Jets Straight	9		
4p	HK™16 Jets Spin	6		
6	Waterfall Features	2		
7	Suction Fittings	3		
8	Floor Drain	1		
10	Tri-Zone Controls	2		
11	Neck Jet Valves	1		
12	Air Controls	2		
13	Waterfall Valve	1		
14	Light	1		
15	Constellation™ Lighting (option)	18		
16	Bather's Control Panel	1		
17	Pump 2 control	1		
19	Aroma Infusions (optional)	1		
20	Aroma Injector (optional)	1		
21	In-Line Dispenser	1		
22	Filter Canisters	2		
24	Speakers	2		
25	Headrest Buttons	4		
26	MicroSilk® Pump 3	1		
27	MicroSilk® Return Fittings (optional)	2		
Physical Specifications			US/CAN	INTL
Dimensions		85.5" x 85.5"	217 x 217 cm	
Height		35"	89 cm	
Corner Radius		12"	30 cm	
Seating Capacity/Positions		5/5	5/5	
Weight Dry		760 lbs	345 kg	
Weight Full		3637 lbs	1650 kg	
Water Capacity		345 gal	1306 l	
Total Therapy Jets		60	60	



ZONE 1A

Upper-body jets.*

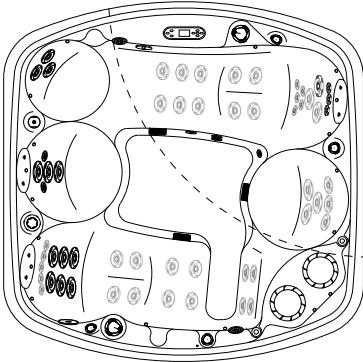

ZONE 2A

Upper-body jets.*

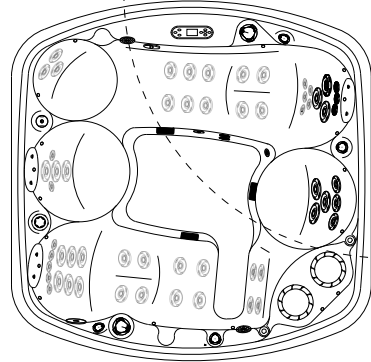

ZONE 1B

HOT Zone shoulder jets.*

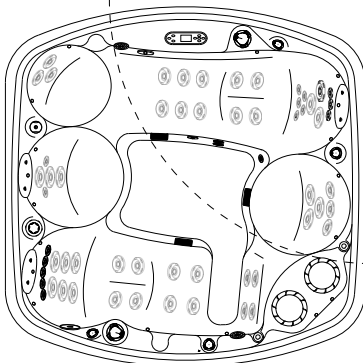

ZONE 2B

HOT Zone lumbar jets.*

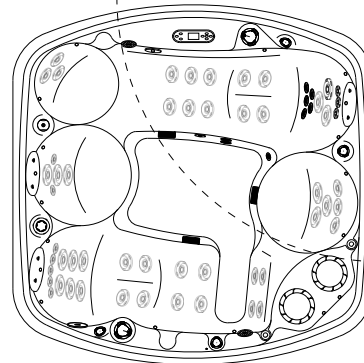

ZONE 1C

Leg and foot jets.*

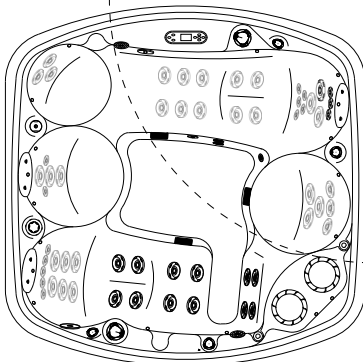

ZONE 2C

Leg and foot jets.*

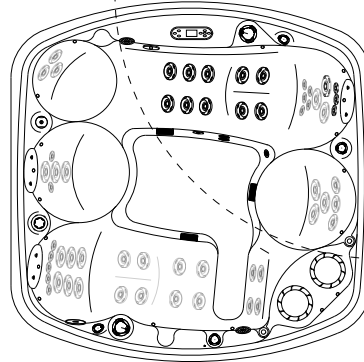

*Neck jets operate in all zones.

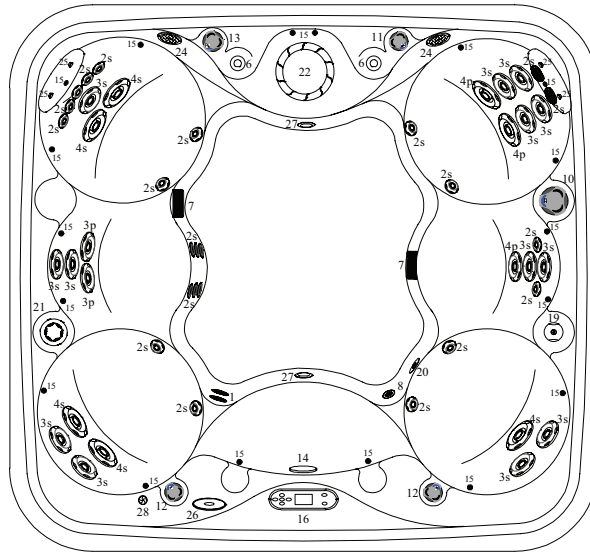

#	Component Identification	Qty.
1	HK™40 Jets	0
2s	HK™8 Jets Straight	23
3s	HK™12 Jets Straight	13
3p	HK™12 Jets Spin	2
4s	HK™16 Jets Straight	5
4p	HK™16 Jets Spin	3
6	Waterfall Features	2
7	Suction Fittings	2
8	Floor Drain	1
10	Tri-Zone Controls	2
11	Neck Jet Valves	1
12	Air Controls	2
13	Waterfall Valve	1
14	Light	1
15	Constellation™ Lighting (option)	18
16	Bather's Control Panel	1
19	Aroma Infusions (optional)	1
20	Aroma Injector (optional)	1
21	In-Line Dispenser®	1
22	Filter Canisters	2
23	Speakers	2
24	Headrest Buttons	4
25	MicroSilk® Pump 3	1
26	MicroSilk® Return Fittings (optional)	2
27	MicroSilk® Air Intake Fitting (optional)	1
Physical Specifications		US/CAN INTL
Dimensions	79" x 85.5"	201 x 217 cm
Height	35"	89 cm
Corner Radius	12"	30 cm
Seating Capacity/Positions	6/7	6/7
Weight Dry	590 lbs	268 kg
Weight Full	3342 lbs	1516 kg
Water Capacity	330 gal	1249 l
Total Therapy Jets	46	46



PROMISE™ 1 PUMP THERAPY CONTROL

ZONE 1A

Upper-body jets.*

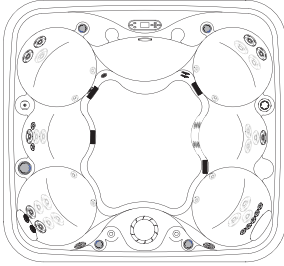

ZONE 1B

Mid-, lower-back jets.*

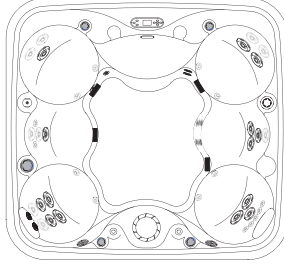

ZONE 1C

Leg and foot jets.*

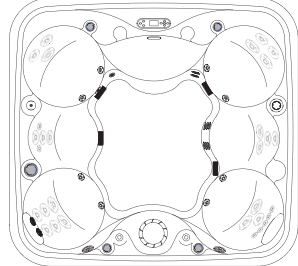

PROMISE™ 2 PUMP THERAPY CONTROL

ZONE 1A

Upper-, mid- and lower-back jets.*

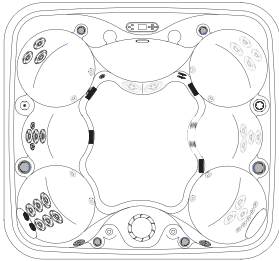

ZONE 2A

Upper-, mid- and lower-back jets.*

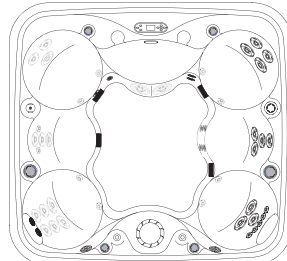

ZONE 1B

Geysier footwell jets.*

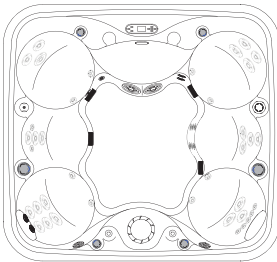

ZONE 2B

Leg and footwell jets.*

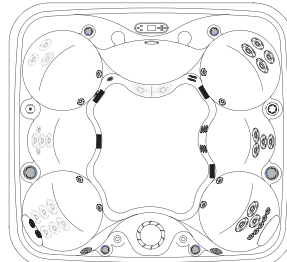

*Neck jets operate in all zones.

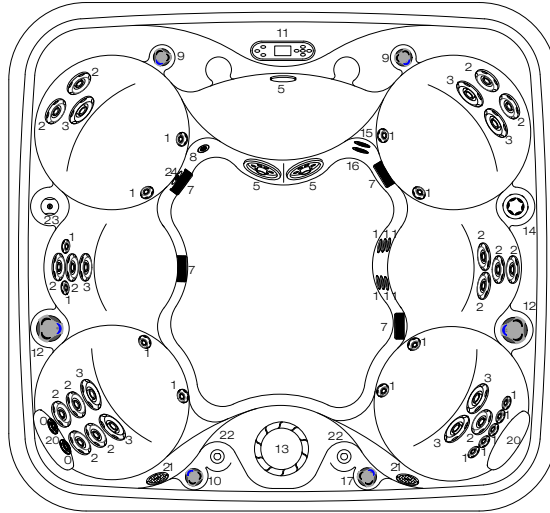

#	Component Identification	Qty.
1	HK™40 Jets	2
2s	HK™8 Jets Straight	23
3s	HK™12 Jets Straight	13
3p	HK™12 Jets Spin	2
4s	HK™16 Jets Straight	5
4p	HK™16 Jets Spin	3
6	Waterfall Features	2
7	Suction Fittings	2
8	Floor Drain	1
10	Tri-Zone Controls	2
11	Neck Jet Valves	1
12	Air Controls	2
13	Waterfall Valve	1
14	Light	1
15	Constellation™ Lighting (option)	18
16	Bather's Control Panel	1
19	Aroma Infusions (optional)	1
20	Aroma Injector (optional)	1
21	In-Line Dispenser®	1
22	Filter Canisters	2
23	Speakers	2
24	Headrest Buttons	4
Physical Specifications		US/CAN INTL
Dimensions	79" x 85.5"	201 x 217 cm
Height	35"	89 cm
Corner Radius	12"	30 cm
Seating Capacity/Positions	6/7	6/7
Weight Dry	630 lbs	286 kg
Weight Full	3382 lbs	1534 kg
Water Capacity	330 gal	1249 l
Total Therapy Jets	48	48

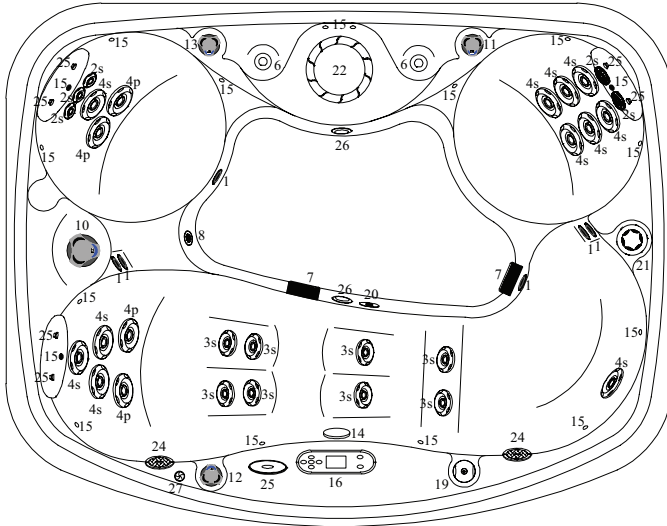

#	Component Identification	Qty.
1	HK™40 Jets	4
2s	HK™8 Jets Straight	5
3s	HK™12 Jets Straight	8
4s	HK™16 Jets Straight	11
4p	HK™16 Jets Spin	4
6	Waterfall Features	2
7	Suction Fittings	2
8	Floor Drain	1
10	Tri-Zone Controls	1
11	Neck Jet Valves	1
12	Air Controls	1
13	Waterfall Valve	1
14	Light	1
15	Constellation™ Lighting (option)	17
16	Bather's Control Panel	1
19	Aroma Infusions (optional)	1
20	Aroma Injector (optional)	1
21	In-Line Dispenser®	1
22	Filter Canisters	1
23	Speakers	2
24	Headrest Buttons	6
25	MicroSilk® Pump 3	1
26	MicroSilk® Return Fittings (optional)	2
27	MicroSilk® Air Intake Fitting (optional)	1

Physical Specifications	US/CAN	INTL
Dimensions	84" x 66"	213 x 168 cm
Height	35"	89 cm
Corner Radius	12"	30 cm
Seating Capacity/Positions	2/3	2/3
Weight Dry	460 lbs	209 kg
Weight Full	2128 lbs	965 kg
Water Capacity	200 gal	757 l
Total Therapy Jets	32	32

ZONE 1A

Upper- and mid-back jets.*

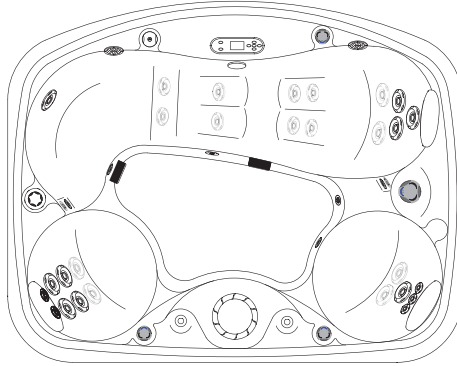

ZONE 1B

Lower-body and leg lounge jets.*

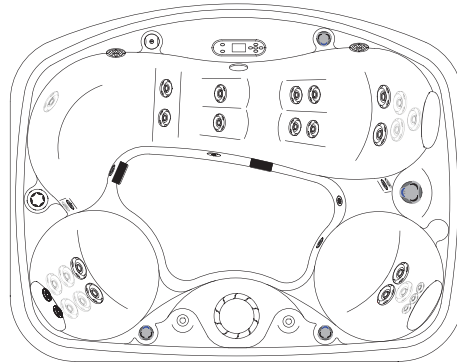

ZONE 1C

Whirlpool jets.*

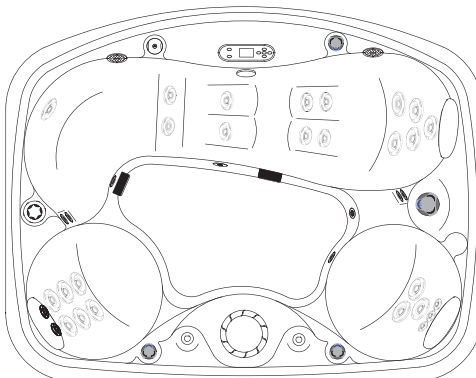

*Neck jets
operate in
all zones.

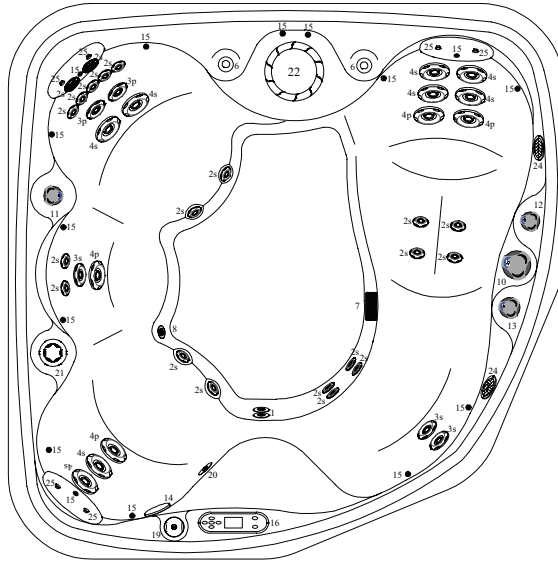

#	Component Identification	Qty.
1	HK™40 Jets	0
2s	HK™8 Jets Straight	21
3s	HK™12 Jets Straight	3
3p	HK™12 Jets Spin	2
4s	HK™16 Jets Straight	8
4p	HK™16 Jets Spin	4
6	Waterfall Features	2
7	Suction Fittings	1
8	Floor Drain	1
10	Tri-Zone Controls	1
11	Neck Jet Valves	1
12	Air Controls	1
13	Waterfall Valve	1
14	Light	1
15	Constellation™ Lighting (option)	15
16	Bather's Control Panel	1
19	Aroma Infusions (optional)	1
20	Aroma Injector (optional)	1
21	In-Line Dispenser®	1
22	Filter Canisters	1
23	Speakers	2
24	Headrest Buttons	6
Physical Specifications		US/CAN INTL
Dimensions	79" x 79"	201 x 201 cm
Height	35"	89 cm
Corner Radius	12"	30 cm
Seating Capacity/Positions	4/5	4/5
Weight Dry	450 lbs	204 kg
Weight Full	2660 lbs	1207 kg
Water Capacity	265 gal	1003 l
Total Therapy Jets	38	36

ZONE 1A
Upper-back jets.*

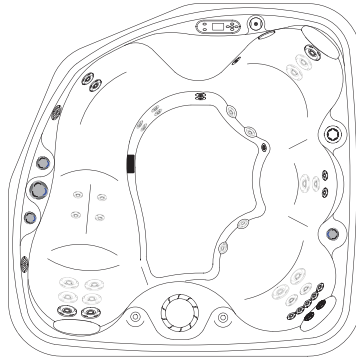

ZONE 1B
Mid-and lower-back jets.*

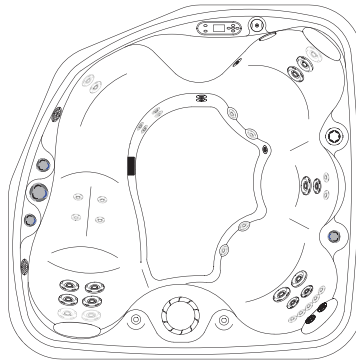

ZONE 1C
Leg and footwell jets.*

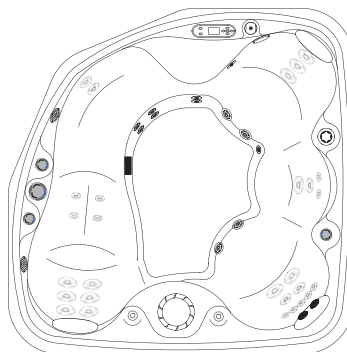

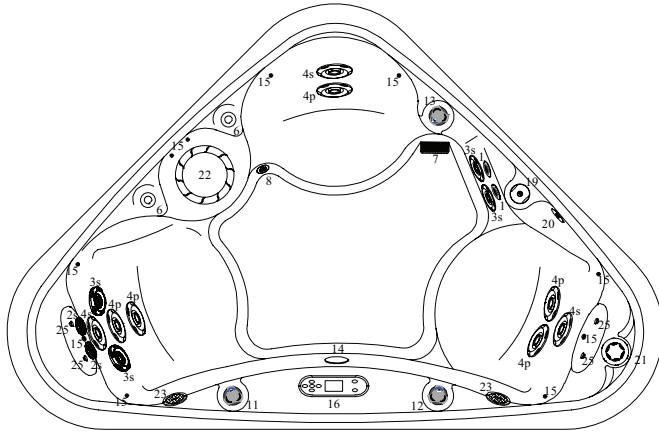

#	Component Identification	Qty.	
1	HK™40 Jets	0	
2s	HK™8 Jets Straight	2	
3s	HK™12 Jets Straight	4	
4s	HK™16 Jets Straight	3	
4p	HK™16 Jets Spin	5	
6	Waterfall Features	2	
7	Suction Fittings	1	
8	Floor Drain	1	
11	Neck Jet Valves	1	
12	Air Controls	1	
13	Waterfall Valve	1	
14	Light	1	
15	Constellation™ Lighting (option)	10	
16	Bather's Control Panel	1	
19	Aroma Infusions (optional)	1	
20	Aroma Injector (optional)	1	
21	In-Line Dispenser	1	
22	Filter Canisters	1	
23	Speakers	2	
24	Headrest Buttons	4	
Physical Specifications		US/CAN	INTL
Dimensions		75" x 75"	191 x 191 cm
Height		29.5"	75 cm
Corner Radius		12"	30 cm
Seating Capacity/Positions		2/3	2/3
Weight Dry		300 lbs	136 kg
Weight Full		1545 lbs	701 kg
Water Capacity		170 gal	644 l
Total Therapy Jets		14	14

**9-Button: Show****8-Button: Epic, Euphoria, Promise 2P, Resort, Reward, Wish****7-Button: Spirit, Mirage, Promise 1P, Rendezvous****PUMP PRIMING (Priming Mode)**

Pump priming feature begins at startup. When your spa is energized, the LCD window displays a "Priming Mode" message. This mode lasts approximately four to five minutes if not exited manually by pressing the BACK/SET pad.

Your hot tub has been configured at the factory to run without any additional programming changes other than setting the desired temperature. We do however recommend that the time is set as this will be shown in the display as a convenience and aids in controlling when the hot tub will filter. See "changing the system settings" below on setting the time.

The hot tub controls are state of the art and will retain all of the settings or changes that have been made in the event of a power failure.

CONTROL PANEL OPERATION INSTRUCTIONS**HOT KEYS****Using pump 1:**

Pressing the Jets 1 button will turn pump 1 on low speed. Pressing a second time will turn the pump on high speed. Pressing the button a third time will turn the pump off. The pump will run for 15 minutes before shutting off or switching to low speed. If the pump continues to run on low speed after the 15 minute timeout, the system is either calling for heat or has entered into a filtration cycle.

Using pump 2 (if equipped):

Pressing the Jets 2 button will turn pump 2 on low speed. Pressing a second time will turn the pump on high speed. Pressing the button a third time will turn the pump off. The pump will run for 15 minutes before shutting off or switching to low speed.

Using pump 3 (if equipped):

Pressing the Jets 3 button will turn pump 3 on low speed. Pressing a second time will turn the pump on high speed. Pressing the button a third time will turn the pump off. The pump will run for 15 minutes before shutting off or switching to low speed.

Light:

Pressing the light button will turn the LED lights on. Pressing a second time will turn them off. If left on the LED lights will automatically turn off after 30 minutes.

Special light feature: You can change the color of the LED lights by pressing the light button repeatedly within 3 second intervals. Doing this will allow you to scroll and choose a specific color or light sequence.

ALL QUIET SOAK FEATURE

Pressing the soak button activates a special feature that turns off all pumps and heater allowing for a quiet soak in the hot water. Pressing the button a second time will restore the unit back to normal operation. If left on, the soak mode will time out after 15 minutes and revert back to normal operation.

Note: Periodically the pump/s may continue to operate for a short time after pressing the soak button. This typically happens when the spa is in a heat cycle as the heater will need a short period to cool down before stopping the water flow.

SETTING THE TEMPERATURE

Pressing the temp up or temp down buttons allow you to adjust the heat to the desired temperature. The set temperature is shown in the left hand side of the LCD display. Pressing and holding the temp up or temp down button will allow for an accelerated change of the temp.

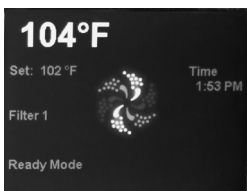

- Factory default temp - 100°F (38°C)
- Maximum set temperature - 104°F (40°C)
- Minimum set temperature - 60°F (16°C)

CHANGING THE SYSTEM SETTINGS

A few basic keystrokes will allow for easy navigation of the available programming options. The settings, soak, temp up and temp down buttons also serve as side to side and up and down navigation controls when in the menu. Note the arrows on the buttons. The back/set button in the center is used to save a setting or go back one screen at a time.

Tip! Note that the menu item that is selected will be brighter in the display than the others indicating where you are in the menu.

Tip! If you have accidentally entered the setting menu, simply press the back/set button or wait 30 seconds to go back to the home screen.

Programming choices shown in the main and sub menus. (see definitions of menu and sub menu items)

Heat Mode (main menu item)

- Ready
- Rest

Time of day (main menu item)

- Current set time

Filter cycles (main menu item)

- Filter cycle 1 and filter cycle 2

Preferences (main menu item)

- Temp display – Choose between Fahrenheit “F” or Celsius “C”
- Time display – choose between 12 or 24 hour display
- Cleanup – choose the length of time of the clean-up cycle
- Language – choose between English, Spanish, French or German

Diagnostics (main menu item)

- Spa
- Information
- A/B Temps
- Fault Log

To make a change, perform the following sequence

1. Press the setting button to display the main settings menu
2. Press the settings button to move over into the main settings menu
3. Scroll down by pressing the temp down button to the desired menu item
4. Press the settings button to move into the sub menu
5. Press the temp up or temp down to change the parameters (note if a change is made, the save and cancel icons appear on the left hand side of the screen)
6. Press the soak button to move to the left to the save icon. Note the save icon will be brighter than everything else.
7. Press the back/set button to save your selection. If you want to cancel your choice use the temp down button to navigate to the cancel icon or simply wait 30 seconds which will end the programming session.

Definitions of menu and sub menu items**Heat mode – Ready or Rest options**

- When in rest mode, the display will show "--".
- The Ready mode will have the spa at the set temperature at all times.
- The Rest mode will only heat during a filtration cycle. This is useful if you are going to be gone for an extended amount of time and want to conserve on power required to keep the spa hot at all times

Time of day

Setting the time of day will establish the current time in the main display screen of the panel. It is also important for controlling when filtration cycles will run.

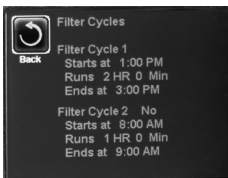
**Filter Cycles:**

- Filter cycle 1 is set at the factory to run for 1 hour two times per day.
- Filter cycle 2 is set at the factory to run for 1 hour two times per day.
- Adjusting the time of the filtration cycle(s) is a matter of personal preference and usage patterns. Setting the filtration cycles for late at night can avoid higher electrical rate costs as an example. If you live in a climate that is seasonally hot, running the filtration cycle at night can avoid unwanted heat build-up from the pumps and prolong the life of the equipment. If your usage patterns are heavy and you would like additional filtration to occur, you have the choice of extending the filtration time or changing the second cycle to a different part of the day.

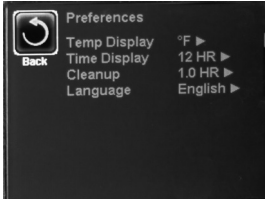

Preferences

- Temp display: Factory set to Fahrenheit “F” but can be changed to Celsius “C” in alignment with local methods of displaying temperature
- Time display: Factory set to 12 hour but can be changed to 24 hour. 12 hour will display “AM” and “PM” after the time if 12 hour is chosen. Choosing 24 hour will display the time in military time.
- Clean-up: Factory set to 30 minutes (.5hr). A clean-up cycle will start 30 minutes after you have finished using the hot tub. You have the ability to extend the clean-up time in .5 hr increments to suit your usage patterns and increase the filtration of the water after use.
- Language: Factory set to English. Choose between English, Spanish, French and German to support your specific language in the display.

Diagnostics

- Spa, Information, A/B Temps and Fault Log are sub menu items used for troubleshooting issues you may encounter with the hot tub operation. These functions can only be viewed and not changed. Typically these functions will be used by a service technician but can be helpful to the owner when reporting an issue to the dealer or service technician over the phone.

OPTIONAL CONTROLS

Auxiliary jet buttons: (if equipped)

Depending on the model of hot tub, there may be up to two auxiliary jet controls for operating the jet pumps. Pressing the Jets button will turn pump on low speed. Pressing a second time will turn the pump on high speed. Pressing the button a third time will turn the pump off. The pump will run for 15 minutes before shutting off or switching to low speed.

Wi-Fi control: (if equipped)

Your hot tub is configured with a special component that will allow wireless control with most Android and Apple® based products such as the Ipad Touch®, Ipad® and Iphone®. This is an exciting feature that allows wireless operation of the spa functions and most settings.

Please note that the typical operating range is within 30 feet of the hot tub depending on obstructions or location/orientation. The signal may not be strong enough in some cases to adequately establish and hold communication between the hot tub and your device especially when operating from indoors and the signal has to travel through walls. Keep this in mind when placing your hot tub during installation in an effort to keep any obstructions to a minimum.

Initial set up:

1. In order to communicate and operate the hot tub, you will need to go to the App Store and download the free “Marquis Spas & Hot Tubs” app to your device.
2. Go to the settings section on your device and choose the “Wi-Fi” tab. Be sure that the Wi-Fi selection slider is set to the “On” position so your device will discover all available Wi-Fi choices. Choose the tab labeled BWG followed by a series of numbers. Be sure your device connects which should be shown by the presence of a check mark next to the name.
3. Return to the main screen and open the Marquis App and proceed to “connect” with the hot tub. Stopping the connection process and restarting may be required. There is nothing wrong with the unit as this can be caused by protocols issued by Apple® Inc.
4. Once connected you will be able to operate the jets and light on the control tab of the App. Moving to the settings tab will allow changing the time, temperature and filtration settings of the hot tub.

Note: If your device goes to sleep, screen darkens, or is turned off you will need to reconnect again with the hot tub in order to reestablish control.

WIRELESS NETWORK SPA CONTROL SETUP INSTRUCTIONS

The new Wi-Fi module expands the peer to peer only functionality of the previous version by incorporating network functionality and cloud control.

What you will need:

1. Owners must get the new Balboa app named: Balboa Water Group – Wi-Fi spa control (the icon will be labeled “spa control”).
2. Make sure your devices Wi-Fi is turned on. Check with your device instructions on how to access your Wi-Fi settings.



3. Router/wireless access information (accessed from wireless access point settings):
 - a. Network security type (WEP, WPA or open)
 - b. SSID (network name - i.e. "home" or "bobs router" etc.)
 - c. Key (Wireless network passphrase, code or password)
4. Viable, stable Wi-Fi signal at the hot tub transceiver location. Stand by the spa and make sure that your phone can see the wireless access point you are trying to connect to. If your phone gets a viable signal the transceiver for the control should as well.
5. Key is the passphrase, password or passcode.
6. The Android version, while similar, will allow you to choose the network from a drop down menu.
7. There needs to be a wireless access point inside the home within range of the hot tub.
8. Connect to the wireless network you set up the transceiver on.
9. Open the spa control app. If you entered the network settings correctly in the previous step you should be able to control your spa.

Connect peer to peer:

1. While standing next to your spa, go to settings/Wi-Fi on your phone. You should see the transceiver on the spa show up as BWGSpa_XXXXX. The X will represent numbers. Select this connection.
2. Go back to the main screen on your phone and open the spa control app. This will allow you to connect peer to peer (phone/device to spa) to control the spa. Verify this works by adjusting jets, lights etc.

Connecting to the Home Network:

1. While connected peer to peer, as above, go into settings. On the bottom click the button named "advanced".
2. Click "Wi-Fi settings" and enter the Wi-Fi settings as follows:
3. Choose the type of security (WEP, WPA or open). This is very important.
4. SSID is the name of the wireless connection, i.e. "home" or "bobs."

USE AND CARE OF AROMA INFUSIONS LIQUID FRAGRANCE DISPENSING SYSTEM (SELECT MODELS ONLY)

Filling

- Turn the top cap of the Aroma Infusions counterclockwise. Remove the pump mechanism to expose the reservoir.
- The reservoir will hold up to 8oz. of liquid aroma. Monitor the level during filling to avoid overfilling. Hold the liquid level approximately 1" below the top during filling to ensure the proper operating level.
- Once filled, replace the pump mechanism into the reservoir and turn the cap clockwise. DO NOT over tighten.

Use

- To dispense aroma into the water, press the small dispensing button in the middle of the cap. When used for the first time, it will take approximately 7 to 8 depressions of the button to fill the line leading to the aroma discharge fitting in the spa. Once filled, each depression of the button will dispense aroma into the water.
- Only use manufacturer's recommended products.



Simply press the dispensing button to reach the desired level of fragrance. The amount of fragrance you desire will be dependent on the number of times you press the button.

- Be aware that it will take a few moments for the fragrance to mix with the water and become apparent above the water level of the spa. Typically two to three depressions of the button will be satisfactory.
- The top button can be locked to avoid accidental use. To lock, simply turn the button clockwise $\frac{1}{4}$ turn. To unlock, turn counterclockwise $\frac{1}{4}$ turn.

Care

- We recommend periodic cleaning of the reservoir and pump mechanism. This is easily done by using removing the top cap and filling with fresh warm water from the tap. After filling, reinstall the cap and press the dispensing button 65 to 75 times. This will empty all of the water from the reservoir and have it ready for refilling with liquid fragrance.
- When switching fragrances you may want to perform the cleaning function to remove any residual of the previous fragrance.
- Routine and periodic cleaning of the filter cartridges is recommended to maintain optimum filtration of the hot tub water. Heavy use or large quantities of dispensed fragrance will accelerate the need for cleaning the filter cartridges.

Your AromaFusion™ canister was developed specifically for use with hot tub liquid fragrances. Use of oils, fragrances and liquids that prove to be corrosive may void your warranty. If you are unsure of what you may use in the AromaFusion™ canister, please consult your local hot tub retailer for the manufacturer's recommended products.

MICROSILK® OPERATING INSTRUCTIONS

- Press the "Start" button on the MicroSilk® panel that is located next to the master control panel to turn on the feature.
 - a. The pump will start and you will notice the presence of the micro bubbles beginning to enter the water from two fittings in the footwell. Do not block these fittings during operation. Periodic bursts of air are normal and will not affect operation or effectiveness.
 - b. It can take up to 8 minutes depending on the size of model to completely fill the water with micro bubbles. You will notice the water will change from clear to milky in appearance.
 - c. If any of the other therapy pumps are on, they will be turned off automatically after pressing the start button and may take up to 30 seconds for pumps to turn off. This is necessary for the proper concentration of micro bubbles to be generated. Running the therapy pumps at the same time will reduce the number of micro bubbles and the effectiveness of the feature.
- The MicroSilk® pump will run for 20 minutes and then automatically turn off. If continued operation is desired, pressing the "Start" button will restart the system for another 20 minutes.



Please note: Periods longer than 20 minutes in elevated temperature may be harmful to your health. Please refer to the safety instructions in the Owner's Manual.

- To manually turn the feature off, press the "Start" button on the MicroSilk® panel one time.
- A clean-up cycle will automatically turn on the filtration pump for 30 minutes after using the feature.

Maintenance Considerations

- Due to the nature of how MicroSilk® works to exfoliate the skin, you may notice higher levels of body oils than normal. This can also be increased if multiple bathers are using the feature at the same time or more frequently. As a result, setting the controls to perform longer filtration of clean-up cycles may be necessary. Please refer to the instructions in the Signature Series Owner's Manual (pg. 41-43) to make a change to the duration of the filtration or clean-up cycle.
- It is recommended to clean the filter cartridge/s once per month to ensure they are free from debris and oils. Failure to do so may result in poor water quality or the ability to properly clean up the water after use.
- It may be necessary to increase the setting on the bromine cartridge located in the inline sanitation housing or increase the amount of other sanitizer you may be using. Checking the sanitizer regularly and adjusting as needed is very important to water safety.

ADAGIO™ AUDIO SYSTEM

Adagio™ Stereo

Adagio is easy to operate with logical push pad controls and function keys. Please refer to the Infinity owner's manual for features, operation, and troubleshooting.

- **CAUTION** - Risk of Electric Shock. Replace components only with identical components.
- Do not operate the audio controls while inside the spa.
- **WARNING** – Prevent Electrocutation. Do not connect any auxiliary components (for example, cable, additional speakers, headphones, additional audio/video components, etc.) to the system, except as provided by the following: The optional 3.5 mm auxiliary jack and USB are designed for input only from devices such as an MP3 player operating at 4.5 V or less.
- These units are not provided with an outdoor antennae; it should be installed in accordance with Article 810 of the National Electrical Code, ANSI/NFPA 70.
- Do not service this product yourself as opening or removing components may expose you to dangerous voltage or other risk of injury. Refer all servicing to qualified service personnel.
- If the power supply connections or power supply cord(s) are damaged; if water is entering any electrical compartment area; or if there are signs of other potential damage to the unit, turn off the unit and refer servicing to a qualified service personnel.
- This unit should be subjected to periodic routine maintenance (for example, once every three months) to make sure that the unit is operating properly.

Adagio™ Audio Expansion Port (optional)

The built-in audio expansion port allows you to connect optional accessories. Use of a MP3 player or USB memory stick are supported. **NOTE:** The 3.5 mm auxiliary jack is designed for input only from devices such as an MP3 player operating at 4.5V or less.

Cloud:

1. The information and requirements for the Cloud connection are supplemental to the Home Network instructions.
2. Wireless access info must be entered and saved.
3. When connected to the cloud a small cloud will appear under “controls” on the top left side of the screen.
4. Outside of the customers network (via 3G, LTE or another wireless connection) the remote app, when active will connect to the spa via the cloud (Balboas servers). This is free for the first 12 months (activated upon the first successful cloud connection). Close to the end of the first 12 months the app will prompt the customer to continue for a small fee.

Glossary:

Peer to Peer: Connect directly to the spa control device.

Network Connect: Wirelessly connect into the owners' network via wireless access point/router. It can control the spa from any compatible device within the network. This eliminates the need to wirelessly connect to the device and back to the network when the individual is done.

Cloud: Connecting to the spa from ANY wireless network anywhere there is an active wireless connection outside of the homeowners' network.

Troubleshooting Info:

- You must have a viable Wi-Fi signal to be able to connect to and control your spa. While standing next to your spa, go to settings/Wi-Fi on your phone. Select the wireless network you set up the transceiver on. If you do not see your Wi-Fi access point or it is not a viable signal, the spa will not be able to connect. You may have to install a signal booster or add an access point to gain a strong enough signal to connect.
- Peer to peer connection may require a couple of attempts to initially connect.
- Make sure you know what security algorithm your wireless connection uses. This will be WEP, WPA or open. This can be found by going in to your wireless devices setting and finding what the setting is.

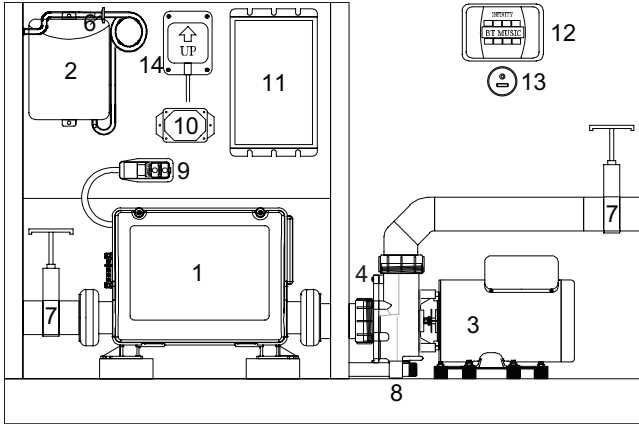
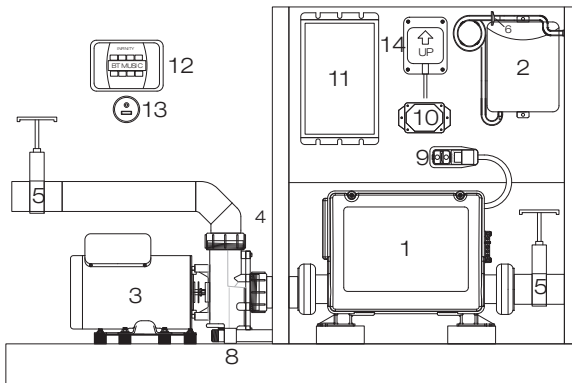
MIRAGE AND RENDEZVOUS

SPIRIT

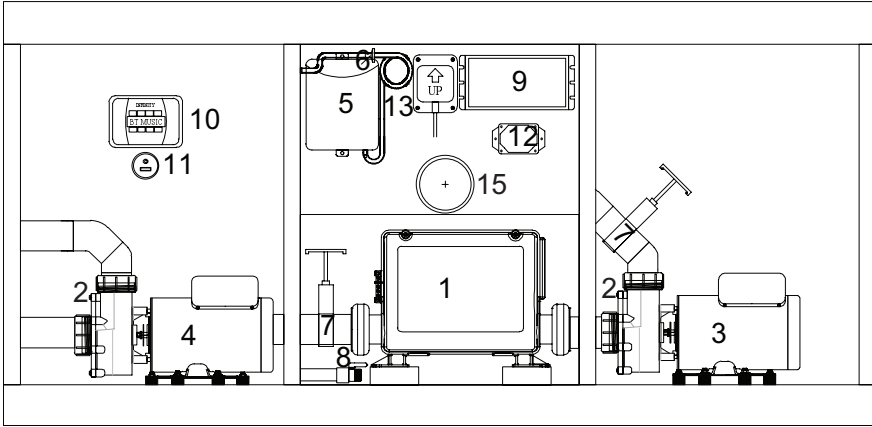
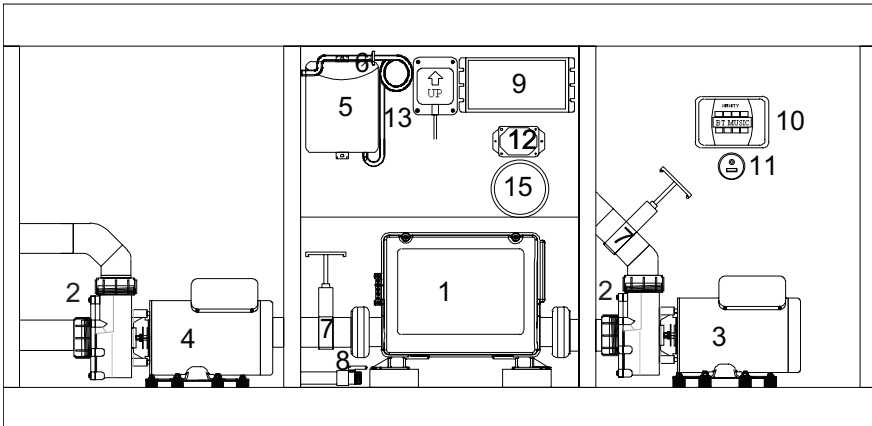
#	Component	Quantity
1	Control Box and Heater	1
2	Ozonator	1
3	Pump	1
4	Pump Unions	2
5/7	Slice Valves	2
6	Check Valve	1
8	Drain Valve	1
9	GFCI	1
10	Light	1
11	Stereo Power Supply (option)	1
12	Adagio™ Stereo Head (option)	1
13	MP3 Auxiliary Jack (option)	1
14	Wi-Fi Transceiver (option)	1

REWARD

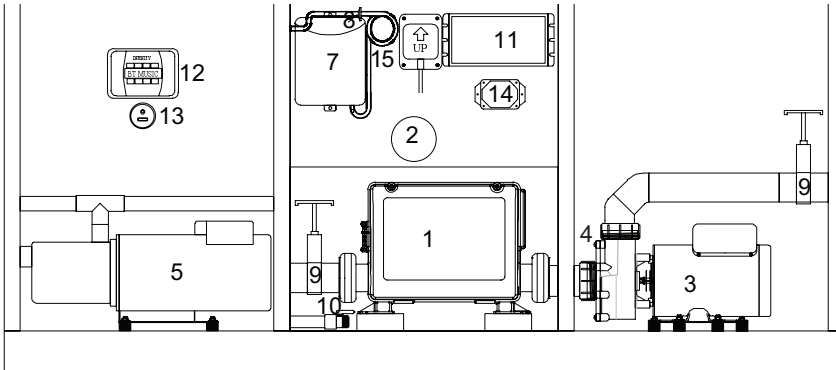
RESORT

#	Component	Quantity
1	Control Box and Heater	1
2	Pump Unions	4
3/4	Pumps	2
5	Ozonator	1
6	Check Valve	1
7	Slice Valves	2
8	Drain Valve	1
9	Stereo Power Supply (option)	1
10	Adagio™ Stereo Head (option)	1
11	MP3 Auxiliary Jack (option)	1
12	Constellation™ LED Control (option)	1
13	Wi-Fi Transceiver (option)	1
15	Light	1

PROMISE 1 PUMP EQUIPMENT DIAGRAM

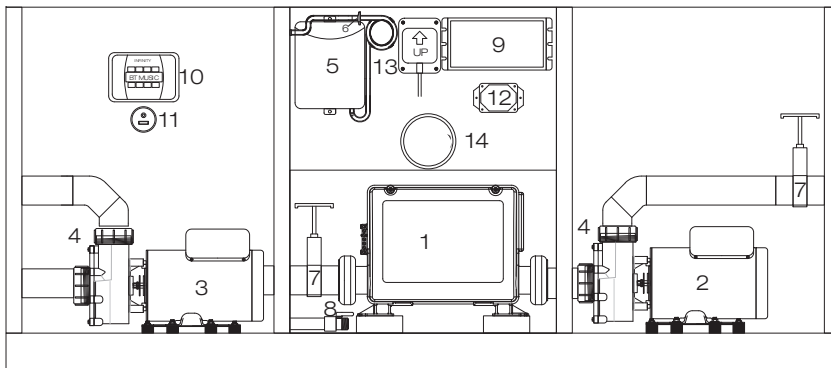
#	Component	Quantity
1	Control Box and Heater	1
3	Pump	1
4	Pump Unions	2
5	MicroSilk® Pump	1
7	Ozonator	1
8	Check Valve	1
9	Slice Valves	2
10	Drain Valve	1
11	Stereo Power Supply (option)	1
12	Adagio™ Stereo Head (option)	1
13	MP3 Auxiliary Jack (option)	1
14	Constellation™ LED Control (option)	1
15	Wi-Fi Transceiver (option)	1

PROMISE 2 PUMP, EPIC, EUPHORIA, WISH EQUIPMENT DIAGRAM

#	Component	Qty	#	Component	Qty
1	Control Box and Heater	1	9	Stereo Power Supply (opt)	1
2/3	Pumps	2	10	Adagio™ Stereo Head (opt)	1
4	Pump Unions	4	11	MP3 Auxiliary Jack (opt)	1
5	Ozonator	1	12	Constellation™ Control (opt)	1
6	Check Valve	1	13	Wi-Fi Transceiver (opt)	1
7	Slice Valves	2	14	Light	1
8	Drain Valve	1			

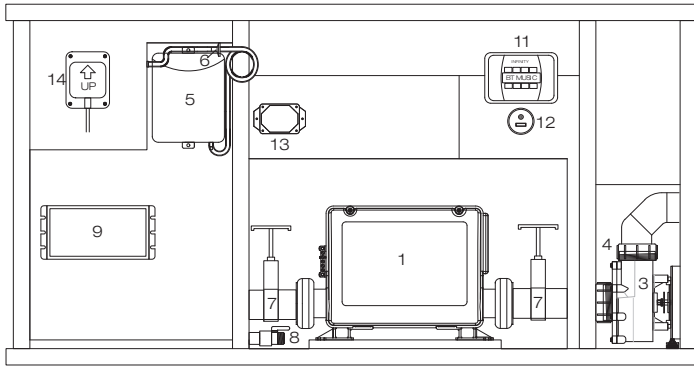
SHOW EQUIPMENT DIAGRAM

#	Component	Quantity
1	Control Box and Heater	1
3	Pumps*	3
4	Pump Unions	6
5	Ozonator	1
6	Check Valve	1
7	Slice Valves	2
8	Drain Valve	1
9	Stereo Power Supply (option)	1
11	Adagio™ Stereo Head (option)	1
12	MP3 Auxiliary Jack (option)	1
13	Constellation™ LED Control (option)	1
14	Wi-Fi Transceiver (option)	1
*	Auxiliary pumps are located in the corners	



PLEASE NOTE: The following corrective actions may be performed by the spa owner. If the trouble cannot be corrected in the steps below, please contact your authorized Marquis® dealer for service. (Improper servicing by an unauthorized service provider or spa owner could result in damage not covered by the warranty and could cause serious injury.)

EQUIPMENT WILL NOT OPERATE

- Check the control panel LCD window for diagnostic code.
- 240V Spas: Check the circuit breaker on the main circuit panel.
- 120V Spas: Check the GFCI power cord and reset if necessary (see **IMPORTANT SAFETY INSTRUCTIONS** at beginning of manual).
- Check the condition of the power cord.

INADEQUATE JET ACTION

- Be sure the shut-off valves in the equipment area are completely open.
- Open the jets by turning the jet face to allow for maximum water flow.
- Check that the air control valve is open (rotate valve counterclockwise).
- Check for obstruction or restrictions at suction guard(s) or filters, such as leaves, etc.

JET VALVES ARE HARD TO OPERATE

- Valves and rotating jets that become hard to turn is an indication of sand, dirt or too high calcium level in the water.
- Remove components and rinse before damage occurs.
- Advise bathers to shower or use a foot bath before entering the spa. Failure to use or maintain valves as directed may cause damage by introduction of foreign materials such as dirt, sand and calcium that is not covered under the warranty.

NO HEAT

- Check temperature displayed in the LCD window for desired temperature setting.
- Inspect the filter cartridge(s) for dirt and debris.
- Check that the water is at proper level, 2/3 up the Vortex skimmer opening(s).
- Check HEAT MODE to be certain spa is not in REST MODE.
- Lower ambient temperatures may result in heat loss.

NOTE: Do not expect instant hot water from the jets. It will take the heater 12- 24 hours to heat the water to the temperature you desire.

GENERAL MESSAGES

Most messages and alerts will appear at the bottom of the normally used screens. Several alerts and messages may be displayed in a sequence. Some messages can be reset from the panel. Messages that can be reset will appear with a “right arrow” at the end of the message. This message can be selected by navigating to it at pressing the Select button.

---°F ---°C

Water temperature is unknown.

After the pump has been running for 1 minute, the temperature will be displayed.

Pump Priming Mode - M019

The pump is in priming mode, you may bypass by pushing any button.

Possible freezing condition

A potential freeze condition has been detected, or the Aux Freeze Switch has closed. All water devices are activated. In some cases, pumps may turn on and off and the heater may operate during Freeze Protection. This is an operational message, not an error indication.

The water is too hot - M029

The system has detected a spa water temp of 110°F (43.3°C) or more, and the spa functions are disabled. System will auto reset when the spa water temp is below 108°F (42.2°C). Check for extended pump operation or high ambient temp.

HEATER-RELATED MESSAGES**The water flow is low - M016**

There may not be enough water flow through the heater to carry the heat away from the heating element. Heater start up will begin again after about 1 minute. See “Flow Related Checks” below.

The water flow has failed* - M017

There is not enough water flow through the heater to carry the heat away from the heating element and the heater has been disabled. See “Flow Related Checks” below. After the problem has been resolved, you must press any button to reset and begin heater start up.

The heater may be dry* - M028

Possible dry heater, or not enough water in the heater to start it. The spa is shut down for 15 min. Press any button to reset the heater start up. See “Flow Related Checks” below.

The heater is too hot* - M30

One of the water temp sensors has detected 118°F (47.8°C) in the heater and the spa is shut down. You must clear the message when water is below 108°F (42.2°C). See “Flow Related Checks” below.

Flow-Related Checks

Check for low water level, suction flow restrictions, closed valves, trapped air, too many closed jets and pump prime.

On some systems, even when spa is shut down by an error condition, some equipment may occasionally turn on to continue monitoring temperature or if freeze protection is needed.

SENSOR-RELATED MESSAGES**Sensors are out of sync - M015**

The temperature sensors MAY be out of sync by 2°F or 3°F. Call for service.

Sensors are out of sync -- Call for service* - M026

The temperature sensors ARE out of sync. The fault above has been established for at least 1 hour. Call for service.

Sensor A Fault, Sensor B Fault - Sensor A: M031, Sensor B: M032

A temperature sensor or sensor circuit has failed. Call for service.

MISCELLANEOUS MESSAGES**Communications error**

The control panel is not receiving communication from the System. Call for service.

Test software installed

The Control System is operating with test software. Call for service.

°F or °C is replaced by °T

The Control System is in Test Mode. Call for service.

SYSTEM-RELATED MESSAGES**Program memory failure* - M022**

At Power-up, the system has failed the Program Checksum Test. This indicates a problem with the firmware (operation program) and requires a service call.

The settings have been reset (Persistent Memory Error)* - M021

Contact your dealer or service organization if this message appears on more than one power-up.

The clock has failed* - M020

Contact your dealer or service organization.

Configuration error (Spa will not start up)

Contact your dealer or service organization.

The GFCI test failed (System could not test the GFCI) - M036

(North America only) May indicate an unsafe installation. Contact your dealer or service organization.

A pump may be stuck on - M034

Water may be overheated. POWER DOWN THE SPA. DO NOT ENTER THE WATER. Contact your dealer or service organization.

Hot fault - M035

A pump appears to be stuck ON when spa was last powered. POWER DOWN SPA IMMEDIATELY. DO NOT ENTER THE WATER. Contact dealer or service organization.

*This message can be reset from the topside panel by pressing any button.

HOW TO PROLONG THE LIFE OF YOUR HOT TUB

There are some simple steps you can take to prolong the life of your hot tub. Please follow the guidelines listed below to ensure the most trouble free and enjoyable use of your spa.

Rinse your feet

Please remember to rinse your feet before getting into the hot tub. This will help prevent sand and dirt from entering the plumbing system where it can clog valves and filters.

Use a suction sock

Please also use a suction sock to further reduce the amount of debris that can enter the plumbing system.

Maintain your valves

If one of your valves begins to feel hard to turn, please remove the valve and rinse it. To remove the valve, please turn the power off to the spa and remove the handle for the valve. Turn the top portion of the valve cap counter clockwise to expose the valve insert. Using the valve stem, please pull straight up on the insert. Rinse the valve and put back the insert into the sleeve and then replace the cap and handle. If the valve is scratched, it is a good idea to use a fine grit sand paper to smooth the valve insert before reinstallation.

Keep the cover on

Always keep your hot tub cover closed when the spa is not in use. This helps prevent unwanted debris from entering the hot tub and prevents sun exposure that could damage the surface and the jets of the hot tub. For full warranty coverage, please note the spa must remain covered at all times when not in use.

Keep the water clear and balanced

Water chemistry is another important part of spa ownership. Please be sure to use only factory recommended products. In addition, please make sure you maintain proper pH and sanitizer levels. Drain and refill your hot tub with fresh water every 3 to 4 months. On a regular basis, please use a spa vacuum to remove dirt and sand that can be seen on the floor of the hot tub.

WEEKLY MAINTENANCE

Removing Debris

Remove any debris and leaves from the Vortex skimmers and suction guard(s) on the inside of the spa. Blocked intakes can impede the flow of water through the jetting system.

Water Level

Replenish the water level if necessary so that it is approximately two-thirds up the Vortex skimmer opening (Marquis) and 4" (102mm) E-Series. (See STARTING YOUR SPA.) Low and high water levels can damage your spa. It is important to check your water level often.



MONTHLY MAINTENANCE

Filter Care

We cannot stress enough the importance of a clean filter for proper water filtration. Dirty filters can restrict water flow, cause hazy water, and prevent your chemicals from working properly. Dirty filters can also cause low flow from jets, poor water clarity and sensors to activate error codes. It is important to clean filters regularly. Many water treatment products clear or clarify the water by clumping microscopic particles and minerals together so that these larger particles can be effectively trapped in the filter. A filter clogged with debris and calcium deposits does not trap particles properly. Soak your filter cartridges in *Filter Cleaner* monthly.

Removing the Filter

Twist lock the filter basket counter-clockwise and lift filter out.

Reinstalling the Filter

Repeat above directions.

CAUTION: Overtightening of the filter can cause the filter or filter housing to crack. Tighten filter until it is just snug.

NOTE: Filters and filter lids do not qualify for labor coverage. These parts can be purchased or exchanged under warranty at your authorized Marquis® dealer.

Leakage Detection

Open the equipment door and check for signs of water leakage around the pump(s). Pump seals wear out over time, especially with improper water chemistry. Early detection of pump seal failure can significantly reduce repair costs. Pump seals, heater gaskets and pump gaskets must be checked each month to ensure they are not leaking. Further damage caused by a leak from any component is not covered under the warranty.

EVERY THREE TO FOUR MONTHS

Draining and Filling the Spa

The average spa needs to be drained every three to four months. After months of continually adding chemicals to the water and introducing body oils and lotions, the water can be difficult to manage and chemicals are not as effective as usual. You may also notice excessive foaming. More frequent draining may be required depending on use.

Draining the Spa

1. Turn off the power to the spa.
2. Open the equipment compartment (see EQUIPMENT DIAGRAM). Remove the hose bib cap from the connection and attach a hose.
3. Open the drain valve. Gravity causes the water to drain out of the hose.
4. When the spa is empty, close the drain valve and remove the hose. Reinstall the hose bib plug.

NOTE: Keep the drain valve closed at all times except when draining the spa (do not rely on the cap to stop the flow of water). Not doing so could result in damage to the drain valve due to freezing water.

Replacing the Mineral Cartridge

The *In-line mineral cartridge* should be replaced every three to four months. You may still feel the “spent” minerals inside, but they are no longer effective and need to be replaced. (See ADJUST THE MINERAL CARTRIDGES, Blue Mineral Cartridge.)

Clean the DuraShell® Interior

Once the spa is drained, clean the DuraShell interior thoroughly – especially at the water line. We suggest the *Glove Sponge* to clean without scratching.

Marquis® Gloss & Guard or Spa Brite is the recommended cleaning agent for DuraShell – other products should be avoided except as stated below.

To maintain the high gloss and elegant look of DuraShell®, just follow these simple steps: For normal care and cleaning use a soft cloth or sponge and water. Rinse well and dry with a soft, clean cloth. Never use abrasive cleaners. Do not allow your acrylic surface to come into contact with products such as ketones or esters such as acetone or ethyl acetate (nail polish remover), Wintergreen oil (methyl salicylate), nail polish, dry cleaning solution or other chlorinated organic solvents, lacquer thinners, gasoline, aromatic solvents, citrus cleaners, pine oil, etc. Remove dust and dry dirt with a soft, damp cloth. Clean grease, oil, paint and ink stains with diluted isopropyl (rubbing) alcohol (do not let alcohol pool or remain on acrylic). Dry with a clean, soft cloth. Avoid using razor blades or other sharp instruments that might scratch the surface.

NOTE: Due to the high-gloss, fine finish of the acrylics, imperfections in the surface texture may occur. A natural aging process in acrylic can lead to a process called crazing. Fine spider web-like lines can form on the cosmetic surface of acrylic over time after exposure to the elements and chemicals.

Crazing represents no structural weakening of acrylic and is not covered under the warranty. Fading, staining and discoloration may also occur but represent no structural degradation and are not covered under warranty.

NOTE: Do not leave an empty spa uncovered. Direct sunlight on the spa surface can cause severe damage or blemishing, cause fittings to discolor and can result in the voiding of any surface warranties.

Refill the Spa

Fill the spa with fresh water from a garden hose and balance the water as described in the Water Treatment section. The use of a *Fill Filter* is recommended when filling especially in areas of high mineral content in the water. Attach to the end of a garden hose to filter out any grit and sediment that could accumulate in the spa and potentially scratch the spa surface.

AS NEEDED MAINTENANCE

Cover Care

It is recommended that you use Marquis *Cover Cleaner* to keep the Dura-Cover™ clean and conditioned. Proper care of the cover increases the life and keeps it looking great in even the harshest conditions. **NOTE:** Do not use regular household products or products that contain silicone, alcohol, steel wool, or bleach.

1. Remove the cover from the spa and gently lean it against a wall or fence.
2. Use a garden hose to spray the cover and loosen and rinse away dirt or debris.
3. Use a large sponge and/or soft bristle brush with a very mild soap solution. Scrub the vinyl top in a circular motion. Rinse vinyl clean before a soap film has a chance to dry.
4. Scrub the perimeter of the cover and side flaps. Rinse clean with water.
5. Rinse off underside of cover with water only (no soap) and wipe clean with a dry rag.
6. Use *Cover Cleaner* to condition the top of the cover after cleaning.

Cushioned Headrest Care

To increase the life of your cushioned headrest, remove and replace them with care only when necessary.

Remove Cushioned Headrest

Slip your fingers under each end of the interior cushioned headrest part and gently pull straight towards you. Damage caused to attachments due to improper removal is not covered under warranty. Pillows and attachments are warranted to be free of defects at delivery only.

Exterior Care

Clean the exterior of the spa with a mild soap and water solution. Cleaners that contain alcohol or high levels of solvents, along with Acetone, Nitrobenzene, and Cyclohexanol, can dissolve and discolor the DuraWood exterior.

Excess Debris

Grit and debris tracked into the spa should be removed with a spa vacuum.

Water Line

To avoid buildup of oils and lotions at the water line, clean the interior weekly or when needed. We suggest the Glove Sponge to clean without scratching.

NOTE: Do not use the same brush or sponge to clean the exterior of the spa and the interior of the spa. Soap and other product residue used on the outside of the spa can cause foaming of the spa water and scratches to the spa surface if used on the inside of the spa.

SUSPENDED USE OR WINTERIZING THE SPA

If you decide to discontinue the use of your spa for any extended period of time, we suggest you follow the steps below.

NOTE: During long periods of inactivity, damage can occur to equipment from condensation within the equipment compartment. Failure to follow these instructions during freezing conditions will result in cracked fitting(s) and glue joints, and other damage.

1. Turn off the power to the spa.
2. Drain the spa. (See DRAINING AND REFILLING THE SPA.)
3. Remove all residual water from the seating and footwell. If necessary, bail out the remaining water then dry the spa with towels. A wet/dry vacuum is recommended for best results.
4. Using the wet/dry vacuum, place vacuum nozzle over each jet nozzle to remove water from plumbing lines, starting with the highest jet and finishing with the lowest jet. **NOTE:** The spa is equipped with a Tri-Zone control which is used to divert water between different jet zones. The valve must be "open" to the particular jets you are vacuuming.
5. Unscrew the pump plug(s) from the pump(s).
6. Again, using the wet/dry vacuum, place nozzle over the exposed pump opening(s) to remove excess water. The pump(s) should be removed from the spa and stored in a climate-controlled room.
7. Clean the spa interior.
8. Clean the filter cartridges.
9. Reinstall the DuraCover™ and lock in place. **NOTE:** Direct sunlight on the spa surface can cause severe damage or blemishing and can result in the voiding of any surface warranties.

VACATION CARE INSTRUCTIONS**Short time periods: 3-5 days**

1. Adjust the pH (see WATER CARE).
2. Sanitize the water by following the shock procedures (See WATER CARE).
3. Lock your spa cover in place with cover locks.
4. Upon return, shock sanitize water.

Long time periods: 5-14 days

1. One day before leaving, set the temperature to approximately 80°F, 27°C.
2. Adjust pH as needed.
3. Shock sanitize water.
4. Upon return, shock sanitize water.
5. Return temperature to original setting.
6. Test water chemistry and adjust as necessary.



IMPORTANT CHEMICAL SAFETY PROCEDURES

1. Always keep chemicals out of reach of children.
2. Read product labels carefully prior to use.
3. When dissolving, always add chemicals to water, do not add water to chemicals. Some dry chemicals should be dissolved prior to adding them to the spa. Using a clean container, dip some water from the spa. Mix until dissolved, then add to circulating water.
4. CAUTION: Do not mix chemicals together. Add them separately to the spa water.
5. All chemical products should be stored in a cool, dry, well-ventilated area where the average temperature does not exceed 90°F (32°C). Keep storage area clean of debris such as rags, newspaper, and combustible materials.
6. Keep chemicals away from open flame or other heat source. Do not smoke near chemicals. If a dry chlorine chemical fire should occur, use water only. Do not use a dry chemical fire extinguisher to attempt to put out the fire.
7. When adding chemicals, always keep the water circulating in the spa with jets in a downward circular pattern for better chemical distribution. Add chemicals to the spa water one at a time. Allow several minutes between any new chemical additions using the jet action to evenly distribute throughout the spa.
8. It is important to leave the spa cover open for 20-30 minutes while shock treating your spa to avoid damage. Do not leave spa unattended while cover is open. Damage such as discoloration or brittle vinyl due to chemical damage is not covered under the warranty.
9. After adding chemicals, wait the amount of time recommended on the chemical container before retesting your water for an accurate reading. Retest your spa water before using.
10. If you have any questions or concerns about the correct procedures for handling chemicals, please contact your authorized Marquis® dealer.

CAUTION: Damage to the spa surface and equipment due to the use of trichlor chlorine, or other harsh chemicals not recommended by Marquis is not covered under warranty.

WATER CARE

There are three things necessary for clean safe water:

1. CIRCULATE: Water has to be circulated regularly; it can not be stagnant.
2. FILTER: Water has to be filtered to remove particulates and debris.
3. SANITIZE: Water has to be sanitized to kill organisms like algae, bacteria and virus.

It is critical to maintain proper water balance to protect the spa heater and other components from damage. Damage to the spa surface and equipment caused by poor chemical or harsh chemical treatment is not covered under the warranty. Discoloration of jet faces, valves and controls are an indication of poor chemical maintenance or exposure to the sun.

Jet inserts and valves do not qualify for labor coverage. These parts can be purchased or exchanged under warranty at your authorized Marquis® dealer. Gaskets and seals are not covered under the warranty. The control system in your Marquis spa will automatically circulate and filter. (See SPA CONTROL OPERATION, ConstantClean™ and SmartClean™ sections.) The sanitation requires minimal effort if done consistently and properly.

To sanitize spa water, three things are required:

1. **BALANCE:** The water must be balanced so the sanitizer can work and spa equipment is protected.
2. **SHOCK:** Shock to oxidize organics and maximize sanitizer efficiency.
3. **SANITIZE:** Maintain a proper level of sanitizer at all times.

UNDERSTANDING WATER BALANCE

Water balance is the interrelation of factors that determine the quality of the spa water. The effectiveness of chemicals and other additives are dependent on all these factors working together or “in balance”. The primary elements to water balance are the calcium hardness, total alkalinity and pH. Always use water treatment products recommended for use in a Marquis spa.

pH Balance

Keeping the pH balanced is the most critical component of water balance. Calcium hardness and total alkalinity act as buffers to stabilize the pH. When they are properly adjusted, the pH will be stable and easy to maintain. The pH is a measure of the relative acidity and basicity of the water. The ideal pH range is 7.4 - 7.6. When the pH falls below 7.2, the water can become corrosive. Low pH can cause damage to metal in the control system and heater, excessive sanitizer consumption, and skin irritation. A pH above 7.8 can be scale-forming and allow metals or minerals in the water to form deposits and stain spa surfaces. pH above 7.8 can also cause eye and skin irritation.

Total Alkalinity

Alkalinity acts as a buffer to prevent the pH from changing as other substances are added to the water. Stability of the pH is directly related to the alkalinity. The alkalinity should be between 80 - 140 ppm. Alkalinity below 80 ppm makes it difficult to stabilize the pH. Alkalinity above 140 ppm may increase the pH and cause cloudy water, scaling, and decreased efficiency of the sanitizer.

Note: *Alkalinity Increaser & pH Increaser* and *Alkalinity & pH Decreaser* will affect both the pH and alkalinity. Generally, smaller additions will change the pH and have a very minor effect on the alkalinity. Larger additions will also affect the pH, but will have a much greater effect on the alkalinity. (Example: If the pH is very high and the alkalinity is within range, adding a few smaller doses of *pH and alkalinity Decreaser* instead of one large dose will reduce the pH with little effect on the alkalinity.)

Calcium Hardness

Do not use soft water in your spa. It is critical to have calcium in your water. The ideal range of calcium is between 200 – 300 ppm. The calcium hardness is normally adjusted when filling or refilling after draining the spa. High calcium levels can cause scale buildup on spa surfaces and equipment. Your spa can be protected against high calcium by using *Metal & Stain Remover* per the directions on the container. Low calcium levels can cause spa water to become highly corrosive and damaging to the equipment components and plumbing. To raise calcium levels, use *Calcium Hardness Increase*.

BALANCE

When initially filling or refilling your spa, follow these steps to achieve proper water balance.

IMPORTANT! Always follow instructions on the chemical container when adding chemicals.

1. Test the spa water using a test strip or test kit. Determine the pH and alkalinity of the water.
2. If adjustments are needed for the pH and/or alkalinity, always balance the alkalinity before balancing the pH. The product(s) you should use to adjust pH and/ or alkalinity are *pH Increaser*, *Alkalinity Increaser* or *pH & Alkalinity Decreaser*. Make any additions per the directions on the bottle and then test and repeat if necessary until all readings are in the desired range.
3. Increase the calcium hardness if necessary.

SHOCK

Initial Treatment

Shock the spa using granular *Chlorine Sanitizer* or non-chlorine *Spa Shock*. Add directly to the spa per the instructions on the container. For the initial treatment, *Chlorine Sanitizer* is preferred as it will also establish a residual of sanitizer. You may shock weekly using non-chlorine shock for low chlorine usage.

Maintenance Treatment

Once bacteria and other wastes are neutralized by the sanitizer, they stay in the water unless oxidized or shocked. Often called chloramines or bromamines, they create dull, cloudy water and can cause odor and eye or skin irritation. Shock treatment rids your spa of these wastes for clear, sparkling water. Shocking with non-chlorine *Spa Shock* or granular *Chlorine Sanitizer* is recommended once a week or whenever the water appears dull or cloudy or has a strong odor. Non-chlorine *Spa Shock* allows use of the spa 15 minutes after shock treatment.

NOTE: A strong bromine or chlorine odor typically indicates the spa needs to be shocked – not that there is too much bromine or chlorine in the water. A properly balanced spa that is shocked regularly will not have an odor.

SANITIZE

ConstantClean™ System (Marquis)

The ConstantClean™ system utilizes a combination of sanitizers to increase water quality and significantly decrease maintenance. The combination of a *In-Line Mineral Cartridge** and the factory installed ozonator greatly reduce the amount of sanitizer required. Instead of the normal 3 - 5 ppm of bromine, you may only need to maintain 1 - 2 ppm of bromine.

NOTE: The use of *Spa Frog®* or *@ease floating cartridges* is recommended. Do not use other floating chemical dispensers or Biguanide. Damage to the spa shell and other internal components can occur.

* The built-in sanitation system is not available in some international markets. However, the ozone system is available on all spa models in all countries. Please see your dealer for recommended alternate treatment method if the built-in sanitation system is not available.

BUILT-IN SANITATION SYSTEM*

After shocking the spa water with *Chlorine Sanitizer granules* or *1-Step Brominating Granules*, bring the spa water to operating temperature. Then install the *In-Line cartridges*.

ADJUST THE MINERAL CARTRIDGE

Remove the protective cellophane wrap from the *In-Line mineral cartridge*. While holding the bottom of the cartridge, turn the top until the number six appears in the setting window.

NOTE: The mineral cartridge should be replaced every three to four months. You will still feel the “spent” minerals inside, but they are no longer effective and the cartridge needs to be replaced. It is recommended to drain and refill the spa at the same time you replace the mineral cartridge.

ADJUST THE BROMINE OR CHLORINE CARTRIDGE

Remove the protective cellophane wrap from the *Spa Frog® bromine* or *@ease w/Smart Chlor cartridge*. Finding the right setting for the sanitizer cartridge will require monitoring your usage for the first few weeks. Begin with an initial setting based on the chart below and monitor sanitizer levels daily for the first week or so, adjusting the cartridge by one setting per day until a 3 - 5 ppm level has been achieved. To adjust cartridge, remove from system and turn to the next highest setting if the sanitizer level is low or the next lower setting if the sanitizer level is high. The sanitizer cartridge needs to be replaced when empty between two and four weeks. Always maintain 3 - 5 ppm of bromine or chlorine.

Suggested *Initial Bromine* or *@ease w/Smart Chlor Cartridge Settings*

Daily filter time	Spa Gallons			
	-250	250-300	300-400	400-500
One hour	2	2	3	4
Two hours	2	2	2	3
Four hours	1	1	2	2



INSTALL THE CARTRIDGES

Locate and remove the cartridge holder cap on the top lip of the spa. Push down and turn the holder counterclockwise to unlock. Lift holder out. Snap the *Spa Frog®* or *@ease mineral cartridge* into the area of the holder marked "MINERALS" (top portion), making sure to line up the indentation near the top of the cartridge with the raised line on the holder. Then snap the *Spa Frog® bromine* or *chlorine cartridge* into the area of the holder marked "BROMINE/CHLORINE". Be sure to line up the indentation on the cartridge with the raised line on the holder. After cartridges are snapped in, return the holder, push down, and then turn clockwise to lock into place. Replace the cap.

CAUTION: Hand-tighten only; avoid over tightening; avoid bending the holder to help prevent damage to the holder. Damage caused due to improper removal or installation of chemical cartridge holder is not covered under the warranty. Cartridge holder is warranted to be free from defects at time of delivery of spa. Chemical cartridge holders do not qualify for labor coverage. These parts can be purchased or exchanged under warranty at your authorized Marquis® dealer.

REMOVE THE CARTRIDGES

Reverse above procedures to remove cartridges.

*The built-in sanitation system is not available in some international markets. See your authorized Marquis® dealer for recommended alternate water treatment method.

WATER CARE REGIMEN

Marquis SpaCare™ products are classified by easy to follow usage guidelines. The information below indicates whether the product should be used daily, weekly, monthly, when filling, or as needed – if special water conditions arise.

DAILY

Sanitizer

Maintain 1 - 2 ppm of bromine, @ease or chlorine at all times.

WEEKLY

Spa Shock

Sanitizer combines with bacteria and neutralizes sanitizer/bacteria on contact. However, the used sanitizer/bacteria particle is still present in the spa water. Used sanitizer in the water emits an odor and causes cloudy water. To oxidize, or rid the spa of this used sanitizer, you must shock the spa once a week. For best results, and to protect your spa cover leave the spa cover open for a minimum of 20 minutes after shocking the water.

NOTE: Additional shocking may be necessary if the spa is under heavy use. For @ease w/Smart Chlor (for use in the US only) you will only need to shock as needed or monthly.



AS NEEDED PRODUCTS

pH Increaser, Alkalinity Increaser

pH & Alkalinity Decreaser

These three products work to raise or lower the pH and alkalinity in the spa. They are only needed if the test strip indicates the levels are not in the ideal ranges.

Water Clarifier

Microscopic particles can pass through the spa filter and create cloudy water. The use of *Marquis SpaCare™ Water Clarifier* combines these microscopic particles into larger particles that can be trapped in the filter to clear cloudy water.

Spa Defoamer

If foam appears in your spa, the action of the jets will keep it from dissipating. The use of *Marquis SpaCare™ Spa Defoamer* instantly rids your spa water of foam.

Metal and Stain Remover

Metal and Stain Remover will remove metals such as iron and copper from spa water.



WATER CARE TROUBLESHOOTING GUIDE

NOTE: If you request a service call and no problem is found with the spa or the problem is not covered by warranty (i.e. chemical damage), you will be charged at the regular service rate.

- P: Problem
- S: Solution

Cloudy Water

- P: Inadequate filtration or dirty filter.
- S: Ensure that the filter is securely installed. Clean or replace filter. Increase the length of clean up and/or filter cycles.

- P: Water is not balanced.
- S: Test water and adjust pH, alkalinity, and sanitizer as needed. Shock to oxidize and destroy organics in the water.

- P: Unfiltered particles or chemically saturated.
- S: Use *Water Clarifier* to combine particles.

- P: High total dissolved solids
- S: Drain, clean, and refill the spa.

Chemical Odor

- P: Too many chloramines/bromamines in the water.
- S: Treat water with *Spa Shock*, then adjust sanitizer level as necessary.

- P: Dull looking water, difficult to manage. High total dissolved solids (TDS) may be the cause.
- S: Drain, clean and refill with fresh water.

Musty Odor

- P: Not enough sanitizer in water – bacteria or algae in water.
- S: Add sanitizer as necessary and shock. Readjust sanitizer level if necessary.

Yellow Water

- P: Low pH and/or low alkalinity.
- S: Test and adjust pH with *pH and Alkalinity Increase*. Adjust alkalinity if necessary.

Foaming

- P: High concentration of body oils, lotions or soaps, as well as excessive organics.
- S: Use *Spa Defoamer* and adjust pH and sanitizer as needed.

Scum Line in Spa

- P: Body oils and dirt.
- S: Use *Glove Sponge* to clean the spa. Test and adjust the sanitizer and pH if necessary. Increase the clean up cycle.



No Sanitizer Reading

- P: Sanitizer level is too low.
- S: Shock and/or adjust *sanitizer cartridge* until the sanitizer registers in the recommended range.

- P: Test strip remains “white” even after sanitizer has been added.
- S: Sanitizer level could be extremely high. It can bleach the reagents on the test strip and give a false reading. Remove spa cover and activate jets and air control. Allow jets to run for 30 minutes. Test water to see if desired level has been reached. Adjust *sanitizer cartridge* to reduce bromine or chlorine level.

High Sanitizer Reading

- P: Too much chlorine or bromine added or dispensed into the spa.
- S: Remove spa cover and activate jets and air control. Allow jets to run for 30 minutes. Test water to see if desired level has been reached. Adjust *sanitizer cartridge* to reduce bromine or chlorine level.

Eye or Skin Irritation

- P: Contaminants or excessive amount of chloramines/bromamines in water.
- S: Treat water with *Spa Shock*. Adjust sanitizer level.

- P: pH is low.
- S: Adjust as needed.

Corrosion of Metal

- P: Low pH.
- S: Adjust pH with *pH and Alkalinity Increase*.

Green Water/Algae

- P: Low sanitizer level or high pH.
- S: Adjust pH, shock and/or adjust *sanitizer cartridge* as necessary.

Erratic pH

- P: Alkalinity and/or calcium hardness are too low causing pH “bounce”.
- S: Test and adjust alkalinity and/or calcium hardness to bring them into the ideal range.

DURAWOOD STEP INSTALLATION (OPTION)

The DuraWood step and mounting brackets may be placed along a straight side of the spa, most often centered to the entry location.

Find the center of the spa side where you want to mount the step. Measure 27.5" (699mm) center spread and mark. Measure 1" (25mm) up from base and mark (see diagram).



1

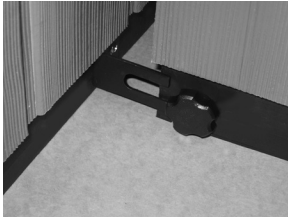

2

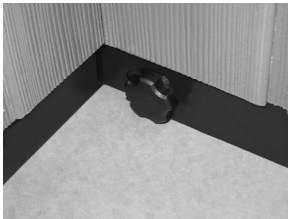

3

- With step mounting brackets facing outwards mark the two holes.
- Using the bracket as a guide, predrill two holes per bracket.
- Attach the left and right brackets to the spa exterior base (#1).
- The step hardware is factory-installed. Loosen the thumbscrew. Gently push step towards the spa until the brackets and hardware engage (#2).
- Tighten the thumbscrew to attach the step to the spa exterior (#3).

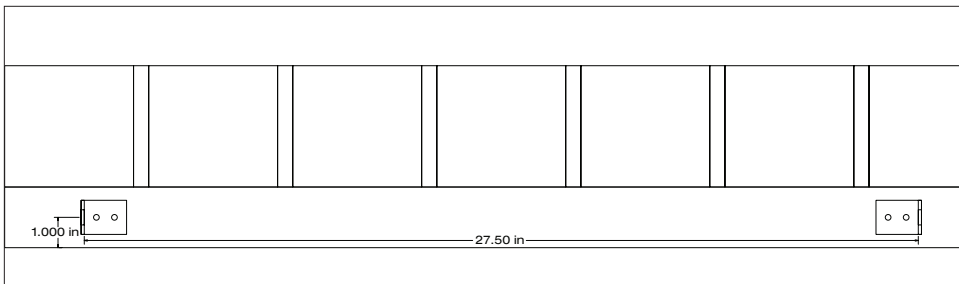

All steps can be inherently dangerous. Always use caution in stepping in and out of your spa.

MARQUIS® LIMITED WARRANTY

(Show, Epic, Euphoria, Reward, Wish, Destiny, Promise, Resort, Spirit, Mirage, Rendezvous)

What the Marquis Corp. Limited Warranty Covers

Marquis Corp. warrants that our products will be free from defects in materials and workmanship for the term set forth exclusively in this warranty. Accessories purchased from Marquis Corp. or a Marquis Corp. authorized Marquis® dealer and added to the spa after manufacture of the spa are not covered under this warranty but may have other warranties. Refer to owner's manual for proper use, maintenance and installation of your spa. The Marquis® Limited Warranty, provided by this Owner's Protection Plan, is made only to the original purchaser of the spa and is not transferable.

[10] STRUCTURE

The reinforced structure is warranted for **10** years not to leak. Fittings and attachments are not included.

[7] SURFACE

The acrylic surface is warranted for **seven** years against blisters, cracks and delamination. The use of a non-Marquis DuraCover will void this warranty.

[5] PLUMBING

Plumbing and fittings are warranted against water loss for **five** years. Warranty coverage does not include gaskets or seals.

[5] EQUIPMENT

Electronic equipment is warranted against defects in materials and workmanship for **five** years. Equipment includes PC boards, pumps, control panels, heater and heat sensors. Adagio™ audio system and associated components have a separate warranty. MicroSilk® system and associated components have a one year parts and labor warranty.

[5] EXTERIOR

The synthetic skirt and DuraBase exterior are warranted against cracking and peeling for **five** years.

[2] COMPONENTS

The ozonator and GFCI cord are warranted against defects in material and workmanship for **two** years.

[1] PARTS

LED lights, RF sensors, remote controls, valves, spa cover, jet inserts, in-line sanitation system and overlays are covered for **one** year. These parts do not qualify for labor coverage under this warranty.

Fuses, non-LED lights, wood exterior, filter, filter lid, cushioned headrests, chemical cartridge holders and other items not specifically mentioned in this warranty are warranted to be free from defects in materials and workmanship at time of delivery. These parts do not qualify for labor coverage under this warranty.

Term of the Marquis Corp. Limited Warranty

The term of your warranty begins on the date the product is sold to you and continues for the term described in this warranty for each component.

What You Should Do if You Experience a Problem

Unless otherwise designated in writing by Marquis Corp., Marquis Corp. or its agent are the only parties authorized to perform warranty service on Marquis Corp. spas. Upon experiencing a problem, please contact your authorized Marquis® dealer.

You will be asked to provide the following information when requesting warranty service: your name, address and contact information; serial number; a description of your spa and a description of the problem. You may be required to provide proof of purchase of your spa prior to receiving warranty service.

What Marquis Corp. Will Do in the Event of a Problem

Marquis Corp. agrees to repair any plumbing or surface defects and to repair or furnish a replacement for any factory-installed component covered under this warranty which, upon test and examination by Marquis Corp., proves to have manufacturing defects. All materials for examination must be returned to Marquis Corp. freight prepaid.

Marquis Corp. will provide parts and labor (according to predetermined schedule) at no charge to repair or replace components that fail due to manufacturing defects. Responding authorized Marquis® dealer may charge additional service and travel fees.

In the event that Marquis Corp. or its agent determines that your problem can be addressed by providing a replacement part to you for installation in your spa, a replacement part will be provided to you at no charge when you return the defective part. All replacement parts assume the original warranty status of the spa into which they are installed, including time remaining on warranty, and have no separate or independent warranty of any kind.

To facilitate repairs, Marquis Corp. or its agent may require access to spa equipment. It is your responsibility to provide unencumbered access.

What the Marquis Corp. Limited Warranty Does Not Cover

No warranty will apply to any spa that has been (i) modified, altered or adapted without Marquis Corp.'s written consent; (ii) maltreated or used in a manner other than in accordance with the spa Owner's Manual; (iii) repaired by any third party not authorized by Marquis Corp.; (iv) improperly installed by any party; (v) used with equipment not covered by this warranty, to the extent that problems are attributable to such use; (vi) relocated to the extent that problems are attributable to the relocation; and (vii) located on any support surface other than specified in the spa printed instructions. Refer to instructions in the owner's manual for proper use, maintenance and installation of your spa.

Other items not included in this warranty are freight expenses; labor and material cost associated with removal and or replacement of the spa; damage to or fading of the spa surface and staining of the spa surface or equipment caused by impact, scratching, abrasive or corrosive cleaners; damage due to extreme water temperatures outside the range of 32°F to 120°F (0°C to 49°C) under any circumstances; or damage to the spa surface or equipment caused by acts of nature, including wind and power surges. Damage to the spa surface and fittings caused by leaving the spa uncovered and empty of water with direct exposure to sunlight may cause solar heat distress and also invalidates this warranty.

Other costs not associated with the direct repair of the spa, such as phone charges and missed work are not included in this warranty. In the event that the Marquis Corp. serial number tag on the spa has been removed or tampered with, the warranty will be void. Customer may not dismantle spas, and any attempt to dismantle systems, other than described herein, constitutes a modification or alteration of the spa which voids the applicable warranty.

LIMITATIONS

Your sole and exclusive remedy and Marquis Corp.'s entire liability in connection with manufacture and sales of its spa products is repair or replacement (at Marquis' option) of a defective part, as expressed in the limited warranty. Any other express or implied representation or warranty, including the implied warranties of merchantability and of fitness for a particular purpose as well as non-infringement, is excluded to the maximum extent permitted by law.

Except as may be required by applicable law, Marquis Corp. shall not be liable for injury, loss, or damage to person or property, however arising, in connection with manufacture or sale of its spa products. This includes indirect, punitive, special, incidental, or consequential damages (including but not limited to loss of use) whether the claim for such injury, loss, or damage is based on breach of contract, breach of warranty, or tort, even if Marquis Corp. has previously been advised of the possibility of such damages.

This limited warranty gives you specific legal rights, and you may also have other rights which vary from state to state.

ADAGIO™ AUDIO SYSTEM ONE YEAR LIMITED WARRANTY

Marquis Corp. warrants to the original retail purchaser, the components of the Adagio™ audio system will be free from defects in material and workmanship for a period of one year from date of purchase. One year coverage includes parts and labor. Optional remote and IR/RF sending unit not included in this warranty: other warranties may apply from the original manufacturer of the optional remote. The Adagio™ audio system Limited Warranty is made only to the original purchaser of the spa and is not transferable.

In no event shall any obligation of Marquis Corp. extend beyond the original period of any applicable warranty determined according to the effective warranty date of the original purchaser.

PERFORMANCE OF WARRANTY

Marquis Corp. agrees to repair or furnish a replacement for any defects in Adagio™ audio system material or workmanship which upon test and examination by Marquis Corp. proves defective. Adagio™ audio components including CD player/radio, speakers, subwoofer, stereo access door, power supply are warranted against defects in material and workmanship for one year. Labor to replace audio components is covered for one year. Water intrusion of any kind is not covered. All materials for examination must be returned to Marquis Corp. freight prepaid.

Your authorized Marquis® Dealer reserves the right to assess travel charges for service calls.

INVALIDATION OF WARRANTY

This warranty is void if the Adagio™ audio system has been subjected to alteration, misuse or abuse or if any repairs on the Adagio™ audio system are performed or attempted by anyone other than an authorized Marquis Corp. service center. Alteration is defined as any component change, electrical conversion or the addition of any alternative sound system components which contribute to component failure.

Misuse and abuse shall include without limitation any external power source attached to the Adagio™ audio system other than approved source, or use in a particular manner that the Adagio™ audio system was not designed, or operation of the Adagio™ audio system other than in accordance with Marquis Corp. printed instruction (located in the Owner's Manual) that leads to any component failure. Under no circumstances shall Marquis Corp. or any of its representatives be held liable for injury to any person or damage to any property, however arising. Other costs not associated to the direct repair of the spa, such as phone charges, missed work, and damage caused to the Adagio™ audio system beyond Marquis® control, are not included in this warranty. Items beyond Marquis® control include but are not limited to damage resulting from: improper connections, accidents, failure to follow procedures defined in the Owner's Manual, damaged from excessive wattage to the system, lightning, extreme temperatures or any other natural occurrences.

IMPORTANT: Some jurisdictions do not allow the exclusion or limitation of incidental or consequential damages, therefore the limitation or exclusions may not apply to you.

DISCLAIMERS

There are no additional warranties, express or implied, which extend beyond the terms of this limited warranty. Marquis Corp. makes no warranty of merchantability of the goods or the fitness of the goods for a particular purpose.

No other person or entity has been authorized to make any warranty, representation or promise of performance not included in this express written warranty, and Marquis Corp. shall not be bound by any such additional warranty, representation or promise.

This warranty gives you specific legal rights. You may also have other rights that may vary from state to state.